

**BARRETT**

2018 CATALOG



Vertical white line on the left side of the page.

Horizontal white line near the bottom center of the page.



## THE BARRETT STORY

Inspiration can come from anywhere. For Ronnie Barrett, inspiration came in 1982, in the form of a river patrol boat featuring two Browning 50-caliber machine guns. A professional photographer at the time, Ronnie was on assignment photographing the boat for a firearms company.

Ronnie found himself drawn to the impressive Browning Ma Deuce. He began to wonder if the powerful 50-caliber cartridge could be fired from a rifle; preferably one operated from a shooter's shoulder. He made it a personal mission to find out.

Ronnie set out to build something no one thought possible—a shoulder-fired 50 caliber rifle so innovative, the Army itself would sing its praises. From sketching his designs at the dining room table to working with a local tool and die maker to create parts that didn't yet exist, every millimeter of the [Model 82](#) was a direct result of his passion for the ultimate firearm.

“When I took those drawings to machine shops for help, instead of getting encouragement, they laughed at my ideas. Not to be discouraged, I just did it anyway. The original Barrett rifle concept has turned into a world-class manufacturing company doing business around the globe,” Ronnie shared.

The obsession with firearms excellence runs deep in the Barrett family blood. Previously serving as the gun maker's lead designer, Ronnie's son, Chris Barrett, now serves as company president. “My earliest memories were of my dad shooting, and his firearms interests. He had machine guns in the 1980s, was a big time hobbyist, always shooting in sub-gun matches. He just had the coolest things in the world to a little boy.”

In his time as lead designer, Chris led the initiative to transition Barrett to a lean manufacturing system, improving their ability to deliver quality products consistently across all categories. “Chris has earned the respect of the people at Barrett by excelling in every role he has performed,” his father shared.

No matter how successful Barrett becomes though, the story keeps evolving. Ronnie explains, “At Barrett, we don't believe in resting on our laurels. In fact, we take great pride in thinking outside the box and exploring ways to continue to improve. After all, if there's one thing our success has taught us, it's this, “you're only as good as your last accomplishment.”

As for that inspiring river patrol boat photo from 1982? Incidentally, that photograph won a first-place award from the Tennessee Professional Photographers Association. To this day, it can be found hanging prominently on a wall at Barrett's Headquarters in Murfreesboro, Tennessee. [i](#)

---

Barrett has grown to be the world leader in long range rifle design and manufacturing. Their products are used by civilian sport shooters, law enforcement agencies, the United States military, and more than 70 State Department approved countries across the world. The Barrett Quality Management System (QMS) has received the prestigious ISO 9001:2015 certification for the design and manufacture of firearms, ammunition, accessories, and in the training provided for those systems.



**Ronnie Barrett | 1982**  
The original 45lbs. prototype of the [Model 82](#)





## CONTENTS

---

- 01 **M107A1®**
- 13 **MODEL 82A1®**
- 25 **MRAD®**
- 37 **REC7®**
- 57 **MODEL 99™**
- 65 **MODEL 95™**
- 69 **240LW & LWS**
- 81 **ACCESSORIES**
- 86 **TRAINING**
- 87 **PRODUCT GUIDE**





M107A1

# M107A1<sup>®</sup>



## ENGINEERED FOR ACTION.

What happens when you combine over 35 years of research and development with feedback from the most demanding military end users? You get the [M107A1](#). While it may share the same iconic look and legendary reliability of legacy Barrett firearms, that is where the similarities end.

Utilizing state of the art design, manufacturing, and materials, every component of the rifle has been engineered to be lighter and stronger than its predecessors. In addition to a 4-pound weight reduction, the M107A1 is optimized for use with a sound suppressor, providing a much needed signature reduction capability to the warfighter. Lighter, stronger, more accurate, and more capable; the M107A1 has truly been engineered for action. ■







M107A1





# M107A1®

It may be related to the Model 82A1®/M107®, but the M107A1 is far from a simple evolution. Driven by the demands of combat, every component was re-engineered to be lighter yet stronger. The result? A high-performance rifle that weighs four pounds less than the original M107 but is every bit as tough.



## FEATURES

- 1 | Thermal cheek guard
- 2 | Back up iron sights
- 3 | Suppressor-ready bolt carrier and buffer assemblies
- 4 | Nickel Teflon® coatings on bolt assembly for reduced maintenance
- 5 | Anti-corrosive coatings
- 6 | Lightweight aluminum upper receiver with integral 23" (58.4 cm) 27 MOA M1913 optics rail
- 7 | 20" (50.8 cm)\* or 29" (73.7 cm) barrel with fully chrome-lined chamber and bore
- 8 | Accepts Barrett QDL Suppressor
- 9 | Lightweight quick detach adjustable bipod
- 10 | 10-round steel magazine with cartridge witness indicators
- 11 | Modular rear hand grip mounted on M1913 rail accepts lightweight monopod
- 12 | Sorbothane® recoil pad
- 13 | 5 lbs. (2.4 kg) overall weight reduction compared to original M107

### Available Colors



Black | OD Green | Tungsten Gray | Flat Dark Earth



# M107A1® Configurations



## M107A1™ 29"

Caliber	Operation	Rail Length/MOA	Barrel Length	Overall Length	Twist	Weight	Mag. Capacity
50 BMG	Recoil Operated, Semi-Automatic	23" (58.5 cm) 27 MOA	29" (73.7 cm)	57" (144.8 cm)	1 turn in 15" (38.1 cm)	28.7 lbs (13.0 kg)	10



## M107A1™ 20"

Caliber	Operation	Rail Length/MOA	Barrel Length	Overall Length	Twist	Weight	Mag. Capacity
50 BMG	Recoil Operated, Semi-Automatic	23" (58.5 cm) 27 MOA	20" (50.8 cm)	48" (122.0 cm)	1 turn in 15" (38.1 cm)	27.4 lbs (12.4 kg)	10





# Barrett Goes Twice the Distance for New Zealand Defence Force



After hitting targets at almost twice the distance of the current issue 7.62 sniper rifle, the 50 BMG Barrett M107A1 anti-materiel rifle and the Multi Role Adaptive Design (MRAD) sniper rifle in 338 Lapua Magnum are being added to the New Zealand Defence Force (NZDF) arsenal.

NZDF entered into an agreement Q4 2017 to buy 40 M107A1 rifles, 42 MRAD sniper rifles, optics, suppressors, accessories, and ancillary equipment as part of a "total system" purchase. The Barrett rifles will serve as part of the NZDF's modernization effort.

Both the M107A1 and MRAD enable soldiers to identify and engage vehicles or targets out to 1500 meters.

The weapons were picked after extensive testing and feedback the NZDF shared. The MRAD specifically was chosen after six weeks of testing various rifles at the Waiouru Military Camp. Over 10,000 rounds were fired during the stringent evaluation process.

Using the latest technology, the Barrett rifles will ensure soldiers are equipped for any battlefield environment they might encounter. "The new weapons will significantly increase the range of NZDF snipers, and with the innovation of new tripods, will increase their ability to shoot in various positions, from prone to standing," explained Major General Peter Kelly, Chief of Army, NZDF. ■

**Starting mid-2018, both the M107A1 and the MRAD will be utilized by infantry units within the New Zealand Defence Forces.**



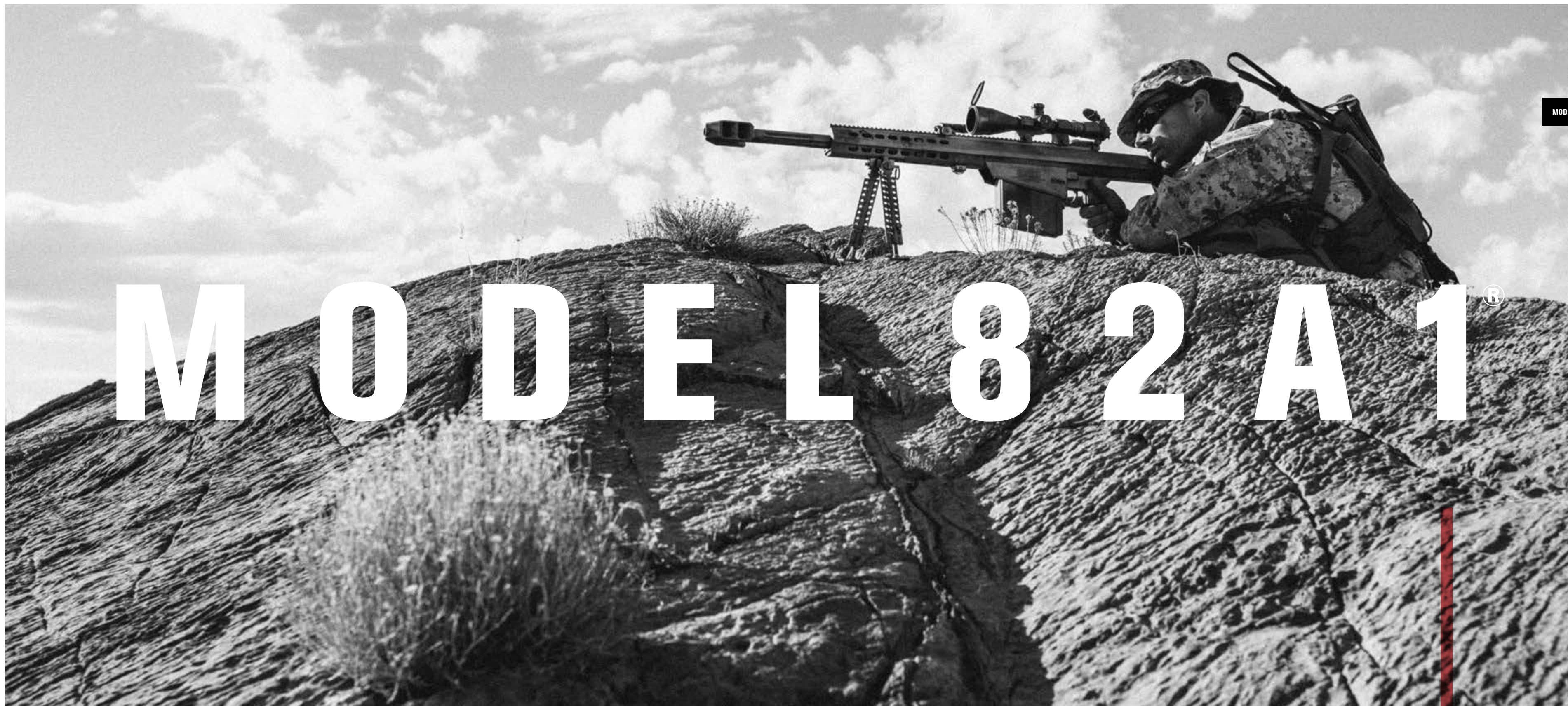

MODEL 82A1®

# MODEL 82A1®







## THE POWERHOUSE RIFLE.

The Model 82 is where the Barrett legacy began. Engineered as the first shoulder fired semi-automatic 50 BMG rifle, the [Model 82A1](#) has been proven in combat in every environment from the snow covered mountains, to the desolate deserts, and everything in between. Its low felt recoil and reliable firepower delivers on target with every pull of the trigger. More than just a rifle, the Model 82 is an American icon. ■







# MODEL 82A1<sup>®</sup>

After 30-plus years of making history, the powerhouse rifle that started it all is still leading the pack. With its low felt recoil and self-loading action, the Model 82A1 offers rapid accuracy that never slows down.



## FEATURES

- 1 | Front and rear sling loops
- 2 | Steel receivers with durable finish
- 3 | Flip up iron sites
- 4 | Semi-automatic recoil operated
- 5 | 23" (58.4) 27 MOA M1913 rail with carrying handle
- 6 | Accepts side accessory rails
- 7 | 20" (50.8 cm) or 29" (73.7 cm) fluted barrel
- 8 | Chrome lined chamber and bore
- 9 | High efficiency arrowhead 2-port brake for 50 BMG and cylindrical 3-port brake for 416 Barrett
- 10 | Quick detach adjustable bipod
- 11 | 10-round steel magazine
- 12 | Rear hand grip accepts adjustable monopod
- 13 | Sorbothane<sup>®</sup> recoil pad

### Available Colors



Black | OD Green | Tungsten Gray | Flat Dark Earth | Burnt Bronze



# Model 82A1® Configurations



## Model 82A1® 29"

Caliber	Operation	Rail Length/MOA	Barrel Length	Overall Length	Twist	Weight	Mag. Capacity
50 BMG 416 Barrett	Recoil Operated, Semi-Automatic	23" (58.5 cm) 27 MOA	29" (73.7 cm)	57" (144.8 cm)	1 turn in 15" (38.1 cm) 50 BMG 1 turn in 12" (30.5 cm) 416 Barrett	32.7 lbs (14.8 kg)	10

*Pictured: 416 Barrett*



## Model 82A1® 20"

Caliber	Operation	Rail Length/MOA	Barrel Length	Overall Length	Twist	Weight	Mag. Capacity
50 BMG	Recoil Operated, Semi-Automatic	23" (58.5 cm) 27 MOA	20" (50.8 cm)	48" (122.0 cm)	1 turn in 15" (38.1 cm)	31.5 lbs (14.3 kg)	10

MODEL 82A1®



*Rifle shown with optional accessories.*



Picture this: you're facing down insurgents in a firefight for your life and your gun stops firing. What do you do?

One US Navy SEAL Commander faced this grim situation on the battlefield in Afghanistan. Unbeknownst to him, the lower receiver was accidentally bent.

Left with limited options, he called Barrett's customer service and Don Cook, a Marine Corps vet, answered the line.

Being on the field, the unit didn't have the tools needed for the repair. Improvising, Cook walked the Commander through the repair using the limited resources he had on hand. It worked.

"It's probably one of the biggest highlights in my life to be able to help a Marine unit in a firefight," Cook said in his National Geographic interview.

Within 30 seconds, the Marines were back in action. ■

**"The reliability and personal service provided by Barrett goes above and beyond what I've ever experienced. Thanks for your help and support while I was on assignment in Helman Province Afghanistan..."**

— Commander, US Navy SEALs

# A Call from the Battlefield

MODEL 82A1\*





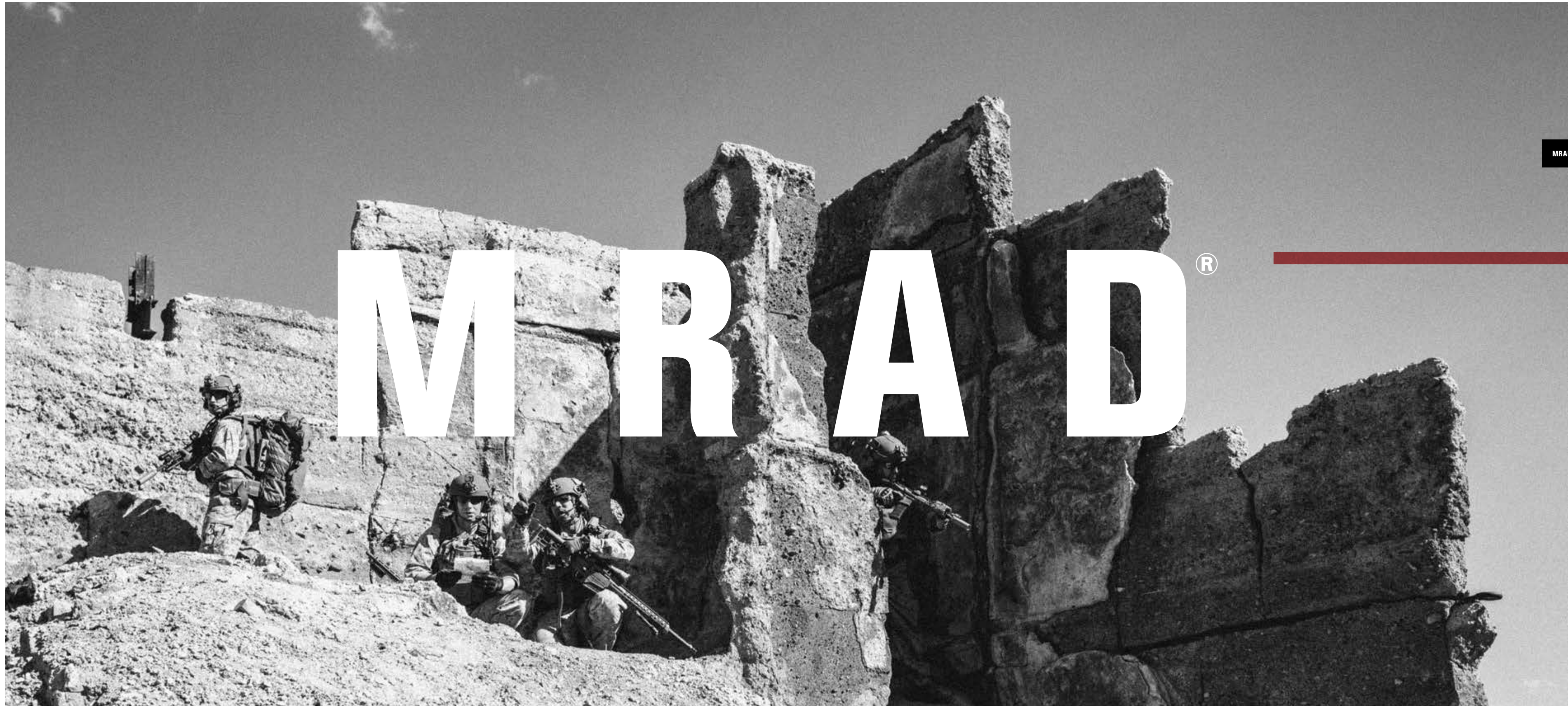

MRAD®

# MRAD®





## MODULARITY WITHOUT COMPROMISE.

Designed with both precision and modularity in mind, the MRAD is equally at home on the range or on duty. Its monolithic upper receiver is machined from 7000-series aluminum, including a full-length M1913 Picatinny top rail with built-in taper for long range precision.

With mounting slots at 3, 6, and 9 o'clock, its hand guard offers a rigid, highly adaptable interface for attachment of rails, electro-optics, and other accessories. Featuring a user-changeable barrel system, the MRAD can quickly and easily be converted to one of 8 different calibers or multiple barrel lengths by simply loosening two bolts using a standard Torx wrench; no gunsmith required.

Contained within the lower receiver is a fully adjustable match-grade trigger module, allowing the user to easily set their ideal pull. The MRAD stock folds on the right side, reducing overall width for a minimal footprint and ease of transport. When extended, the stock locks securely into place, providing an interface as rigid and stable as any fixed-stock rifle.

With tool-less length of pull and cheek piece height adjustment, the MRAD is easily configured to fit shooters of all shapes and sizes. The use of ambidextrous paddle-style magazine release, left/right swappable thumb safety and AR15/M16 pistol grips makes the MRAD perfect for both right and left handed shooters. From competition to combat, the Barrett MRAD does it all. ■





MRAD®



# MRAD<sup>®</sup>

Ready to follow your every move, the **MRAD** adapts to a variety of user needs without sacrificing performance. With unfailing accuracy, this bolt-action system continues to define a whole new class of long-range precision rifles.



## FEATURES

- 1 | Length of pull adjustable by push button
- 2 | Polymer cheek piece is height adjustable from either side
- 3 | Lightweight folding stock provides compact mobility
- 4 | Polymer bolt guide acts as dust cover and provides smooth bolt cycling
- 5 | Integral 20 MOA 22" (55.9 cm) M1913 optics rail
- 6 | Mil-Spec Type 2, Class 3 Hardcoat anodized available in Cerakote<sup>™</sup>, Black, Flat Dark Earth, OD Green, Tungsten Grey, & Burnt Bronze
- 7 | Multiple length accessory rails can be mounted at 3, 6, and 9 o'clock positions
- 8 | Match grade barrels available in multiple lengths and profiles

- 9 | High efficiency muzzle brake
- 10 | User changeable calibers
- 11 | Relief cut magazine well for quick reloads
- 12 | 10-round, drop free, polymer magazine
- 13 | Ambidextrous magazine release is accessible while maintaining firing grip
- 14 | Oversized trigger guard for operation with gloved hands
- 15 | Fully adjustable trigger module can be removed without tools
- 16 | Accepts most standard M4/M16 pistol grips
- 17 | Thumb-operated safety configurable for right/ left-handed operation
- 18 | Sorbothane<sup>®</sup> recoil pad

### Available Colors



Black | OD Green | Tungsten Gray | Flat Dark Earth | Burnt Bronze

*Rifle shown with optional accessories.*



# MRAD® Configurations



## MRAD® FLUTED

Caliber	Operation	Rail Length/MOA	Barrel Length	Overall Length	Twist	Weight	Mag. Capacity
338 Lapua Magnum	Bolt Action Repeater	21.75" (55.2 cm) 20 MOA	20", 24", 26" (50.8, 62.0, 66.0 cm)	43.4"-47.4" (110.2 cm-120.3 cm)	1 in 9.4" (24 cm)	13.0 lbs-13.8 lbs (5.9 kg-6.3 kg)	10
300 Winchester Magnum			24" (62.0 cm)		1 in 10" (25 cm)		
7mm Remington Magnum			24" (62.0 cm)		1 in 8.5" (21 cm)		
308 Winchester			22" (56.0 cm)		1 in 10" (25 cm)		
6.5 Creedmoor			24" (62.0 cm)		1 in 8" (20 cm)		
260 Remington			24" (62.0 cm)		1 in 8" (20 cm)		



## MRAD® HEAVY

Caliber	Operation	Rail Length/MOA	Barrel Length	Overall Length	Twist	Weight	Mag. Capacity
338 Lapua Magnum	Bolt Action Repeater	21.75" (55.2 cm) 20 MOA	20", 24", 26" (50.8, 62.0, 66.0 cm)	40.4"-49.4" (102.6 cm-125.4 cm)	1 in 9.34" (24 cm)	11.7 lbs-13.4 lbs (5.3 kg-6.1 kg)	10
300 Winchester Magnum			24" (62.0 cm)		1 in 10" (25 cm)		
7mm Remington Magnum			24" (62.0 cm)		1 in 8.5" (21 cm)		
308 Winchester			17" (43.2-56 cm)		1 in 10" (25 cm)		
6.5 Creedmoor			24" (62.0 cm)		1 in 8" (20 cm)		
260 Remington			24" (62.0 cm)		1 in 8" (20 cm)		



## MRAD® CARBON FIBER

Caliber	Operation	Rail Length/MOA	Barrel Length	Overall Length	Twist	Weight	Mag. Capacity
338 Lapua Magnum	Bolt Action Repeater	21.75" (55.2 cm) 20 MOA	24" (62.0 cm)	40.4"-47.4" (102.6 cm-120.3 cm)	1 in 9.4" (24 cm)	11.4 lbs-12.7 lbs (5.2 kg-5.7 kg)	10
300 Winchester Magnum			24" (62.0 cm)		1 in 10" (25 cm)		
308 Winchester			17 & 22" (43.2-56 cm)		1 in 10" (25 cm)		
6.5 Creedmoor			24" (62.0 cm)		1 in 8" (20 cm)		
260 Remington			24" (62.0 cm)		1 in 8" (20 cm)		



Rifle shown with optional accessories.



# Equipped with the MRAD, Norwegian Armed Forces Take NATO Sniper Team Competition



Being part of the European Best Sniper Squad competition is an opportunity most precision shooters dream of. The five-day competition takes place on the steep hills, muddy rivers, and shadowed forest paths of Grafenwoehr, Germany.

The competitors' skills are put to the test through 30 different challenges including: a high-angle shoot from a helicopter, a water shoot from a boat, advanced marksmanship and night shooting, land navigation, stalking, medical simulations, and more. The highly trained Norwegian Armed Forces and unfailing accuracy of the MRAD earned the squad top honors.

The Norwegian Armed Forces faced international sniper squads from Belgium, Denmark, Italy, Latvia, Lithuania, the Netherlands, Norway, Spain, Sweden, the United Kingdom, and the United States. ■

**“We promised, and we delivered!  
Our sniper team won the NATO  
Sniper Team competition!  
Much thanks to your MRAD.”**

—Master Sniper Instructor, Norwegian Armed Forces





# REC 7<sup>®</sup>

REC7





## ELIMINATE ALL DOUBT.

The REC7 combines the familiar ergonomics of the AR style rifle with a revolutionary short stroke gas piston operating system to create a rifle that runs cleaner and more reliably than traditional designs.

Unlike direct impingement firearms that release gas into the upper receiver, the REC7 piston vents excess gas forward at its patented chrome-lined, fluted gas block, resulting in cleaner, cooler, lower-maintenance operation. The black nitride coated gas block features two positions for suppressed or unsuppressed shooting, ensuring reliability of the shot and helping to avoid unnecessary wear from over speeding the action. It also allows the user to access the piston assembly for maintenance via the front of the rifle without requiring removal of the hand guard or barrel.

The one-piece 17-4 stainless piston interfaces with a strike face that has been machined into the monolithic, anti-tilt bolt carrier.

Reengineered and reinforced for piston applications, the TB-41 DLC coated, anti-tilt, full auto bolt carrier is machined from a solid block of 8620 steel with an integrated piston strike face. It's magnetic-particle inspected, and proof tested before leaving the factory.

Both upper and lower receivers are forged from 7075-T6 aluminum, Type 3 Class 2 hardcoat anodized for durability, then finished with Cerakote for a perfect color match. The upper receiver and barrel extension feature M4 feed ramps for improved reliability, while the lightweight, free float handguard features a full-length M1913 Picatinny top rail with Magpul M-LOK accessory mounting slots at the 3, 6, and 9 o'clock positions.

Available in 5.56 NATO and 6.8 SPC, the REC7 is the first choice when your life depends on it. ■







# REC7<sup>®</sup>

Compact, accurate and completely trustworthy, the REC7 is designed specifically for situations in which there's no room for error. Styled in the familiar AR configuration, it's a serious rifle you can trust with anything—including your life.



REC7

## FEATURES

- 1 | 6-position stock
- 2 | Integrated strike face, anti-tilt bolt carrier
- 3 | Bolt carrier group is plated in a super-tough TB-41 DLC coating
- 4 | Barrett M-LOK<sup>®</sup> handguard
- 5 | One piece piston
- 6 | Two-position gas plug
- 7 | Barrett 3-prong flash hider or muzzle brake
- 8 | Beveled magazine well for rapid changes
- 9 | Enhanced trigger guard allows access with gloves

## Available Colors



Black | OD Green | Tungsten Gray | Flat Dark Earth | Burnt Bronze

*Rifle shown with optional accessories.*



# REC7® Configurations



## REC7® CARBINE

Caliber	Operation	Barrel Length	Twist	Overall Length	Weight	Mag. Capacity
5.56 NATO	Gas Piston System; Semi-Automatic	16" (40.6 cm)	1 in 7" (17.8 cm)	33.25" (84.5 cm)	7.2 lbs. (3.3 kg)	30
6.8 SPC		1 in 10" (25.4 cm)				



## REC7® FLYWEIGHT

Caliber	Operation	Barrel Length	Twist	Overall Length	Weight	Mag. Capacity
5.56 NATO	Gas Piston System; Semi-Automatic	16" (40.6 cm)	1 in 7" (17.8 cm)	34.5" (87.6 cm)	6.1 lbs. (3.3 kg)	20



## REC7® DMR

Caliber	Operation	Barrel Length	Twist	Overall Length	Weight	Mag. Capacity
5.56 NATO	Gas Piston System; Semi-Automatic	18" (45.7 cm)	1 in 7" (19.6 cm)	38.3" (97.6 cm)	7.91 lbs. (3.6 kg)	20



## REC7® SBR

Caliber	Operation	Barrel Length	Twist	Overall Length	Weight	Mag. Capacity
5.56 NATO	Gas Piston System; Semi-Automatic	11.5" (29.2 cm)	1 in 7" (17.8 cm)	25.9" (65.7 cm)	6.1 lbs. (2.3 kg)	30

REC7®







## THERE'S NO EXCUSE NOT TO OWN THE WORLD'S FINEST CARBINE

With a nod to Eugene Stoner and his direct impingement design, Barrett is proud to produce the REC7 DI: a lightweight, modular, accurate AR that even the most die hard traditionalist can appreciate. Featuring a lengthened gas system for reliability with or without a suppressor, the REC7 DI is truly a pleasure to shoot. The upper and lower receiver are machined from 7075-T6, with all aluminum components coated in Type 3 Class 2 hardcoat anodizing, then finished with Cerakote for a perfect color match. Every human touch point has been considered and refined using the finest accessories, including Magpul furniture, custom Radian Raptor ambidextrous charging handle, Geissele or ALG Defense trigger, and extended slimline Barrett hand guard with Magpul M-LOK accessory mounting slots.

Available in 5.56 NATO, 6.8 SPC, and 300 BLK, every REC7 DI is hand built one at a time, inspected, and tested to ensure it lives up to the quality and reliability you expect from the Barrett name. ■





# REC7<sup>®</sup> DI

After years of raising the bar on long-range shooting with our 50 caliber, Barrett has now created our next generation AR. We call it the **REC7 DI** and while incredibly light, it carries some truly weighty attributes.

REC7<sup>®</sup>

## FEATURES

- 1 | 6-position stock
- 2 | Radian charging handle
- 3 | Magpul backup iron sights
- 4 | Bolt carrier group is plated in a super-tough TB-41 DLC coating
- 5 | Unique Barrett gas block easily serviceable by users
- 6 | Barrett high-precision barrel
- 7 | Barrett 3-prong flash hider or muzzle brake
- 8 | Comes with the Barrett M-LOK<sup>®</sup> rail system handguard installed
- 9 | ALG QMS Trigger

## Available Colors



Black | OD Green | Tungsten Gray | Flat Dark Earth | Burnt Bronze

*Rifle shown with optional accessories.*



# REC7 DI® Configurations



## REC7 DI® SBR

Caliber	Operation	Barrel Length	Twist	Overall Length	Weight	Mag. Capacity
5.56 NATO	Direct Impingement System; Semi-Automatic or Select Fire	10.25" (26.0 cm)	1 in 7" (17.8 cm)	30.25" (76.8 cm)	5.5 lbs. (2.5 kg)	30
300 Blackout			1 in 7" (17.8 cm)			



## REC7 DI® CARBINE

Caliber	Operation	Barrel Length	Twist	Overall Length	Weight	Mag. Capacity
5.56 NATO	Direct Impingement System; Semi-Automatic or Select Fire	16" (40.6 cm)	1 in 7" (17.8 cm)	36" (91.4 cm)	6.2 lbs. (2.8 kg)	30
6.8 SPC			1 in 10" (25.4 cm)			
300 Blackout			1 in 7" (17.8 cm)			



## REC7 DI® DMR

Caliber	Operation	Barrel Length	Twist	Overall Length	Weight	Mag. Capacity
5.56 NATO	Direct Impingement System; Semi-Automatic or Select Fire	18" (45.7 cm)	1 in 7" (17.8 cm)	38" (96.5 cm)	6.5 lbs. (2.9 kg)	20



REC7®



# True to Their Roots, Barrett Arms Tennessee Law Enforcement

“When the Barrett story is told, folks usually talk about the civilian shooters and militaries around the world that have chosen Barrett long-range precision rifles for more than three decades. Less-often mentioned is my father’s background as a county sheriff’s deputy, our 5.56 carbines and rifles, and the countless law enforcement agencies that choose Barrett. We want to highlight that legacy and show our strong support for law enforcement by donating these Barrett REC7 DI rifles to the sheriffs in our state,” Chris Barrett, Barrett President, said during remarks at the 2016 Tennessee Sheriff’s Association Annual Conference & Exhibition.

“As lifelong Tennesseans and builders of the Barrett Model 82A1/M107, the ‘Official State Rifle of the State of Tennessee,’ we are proud to build every one of these rifles in Tennessee. We believe that the sheriffs can use these rifles as they enforce the laws around this great state.”

**In total, Barrett donated 95 Barrett REC7 DI rifles, one to each Tennessee county sheriff’s office or department.**





# MODEL 99<sup>TM</sup>

MODEL 99<sup>TM</sup>



# MODEL 99™

Rugged. Reliable. Uncomplicated. The **Model 99** is designed for one thing only: to get the job done. With its brilliantly simple design, hard-core construction, and surprisingly few moving parts, it offers match-winning accuracy time and time again.



MODEL 99™

## FEATURES

- 1 | One piece aluminum extrusion receiver
- 2 | Easy feed, single shot
- 3 | Interrupted, buttress-threaded bolt for superior lock up
- 4 | Black Mil-Spec Type 3, Class 2 hardcoat anodized base with Cerakote finish
- 5 | 13.75" (34.9 cm) 27 MOA attached M1913 optics rail
- 6 | Match grade 29" fluted\* or 32" heavy barrel
- 7 | Available in 50 BMG or 416 Barrett
- 8 | 3-port high efficiency muzzle brake
- 9 | Match-quality trigger
- 10 | Quick-release assembly pins
- 11 | Rear hand grip accepts adjustable monopod
- 12 | Sorbothane® recoil pad

### Available Colors



Black | Flat Dark Earth



# Model 99™ Configurations



## MODEL 99™ FLUTED

Caliber	Operation	Barrel Length	Barrel Twist	Overall Length	Weight	Capacity
50 BMG	Single Shot Bolt Action	29" (73.6 cm)	1 in 15" (38.1 cm)	47" (119 cm)	23 lbs (10.4 kg)	Single Shot



## MODEL 99™ HEAVY

Caliber	Operation	Barrel Length	Barrel Twist	Overall Length	Weight	Capacity
50 BMG	Single Shot Bolt Action	32" (81.3 cm)	1 in 15" (38.1 cm)	50" (127.0 cm)	25 lbs (11.4 kg)	Single Shot
416 Barrett		1 in 12" (30.5 cm)				



MODEL 99™



# Barrett Model 99 Takes Home 2nd Place in the 2017 King of 2 Miles



Shooting a stock Barrett Model 99 chambered in 416, Barrett walked away with a 2nd place finish at the 2017 King of 2 Miles (KO2M). Shooter Ronnie Wright was named "Prince" of The 2 Mile displaying Barrett's ability to deliver precision fire on Extended Long Range (ELR) targets from a production rifle.

The KO2M is a two-day, team competition held at the world-renowned NRA Whittington Center in Raton, NM. Teams consist of one shooter with up to two wind coaches/spotters assisting. Founded in 2015, the competition continues to bring expert shooters who outperform the best distances from the year before.

While sheer shooting skills contribute to these high marks, firearm advancements have helped make the impossible possible. In real world conditions, all components need to come together to make the shot—the rifle, bullets, optics, ballistics program, bipod and team members—and work seamlessly.

Spectators were surprised to see a stock rifle finish second overall against the full-custom rifles on the firing line, speaking volumes to the quality and performance of the Barrett M99. ■

MODEL 99

## HERE'S A LOOK AT RONNIE WRIGHT'S KO2M SETUP:

<b>Rifle:</b>	Production Barrett Model 99
<b>Cartridge:</b>	416 Barrett
<b>Optics:</b>	Nightforce ATACR scope
<b>Bipod:</b>	Phoenix Precision
<b>Brass:</b>	Barrett 416 brass
<b>Powder:</b>	RL50
<b>Bullet:</b>	Cutting Edge Bullets 472gr MTAC
<b>Primer:</b>	CCI #35
<b>Level:</b>	Accuracy First
<b>Barrel Length:</b>	32"





# MODEL 95<sup>TM</sup>

MODEL 95<sup>TM</sup>



# MODEL 95™

The **Model 95** may weigh in at a smaller class, but packed into its lightweight bullpup design is the intense power of a 50 caliber magazine-fed firearm, the pinpoint accuracy of a bolt-action rifle, and the effortless functionality of a perfectly designed machine.



## SPECS

<b>Model:</b>	Model 95
<b>Caliber:</b>	50 BMG
<b>Operation:</b>	Bolt Action Repeater
<b>Weight:</b>	23.5 lbs (10.7 kg)
<b>Rail Length/MOA:</b>	11.75" (29.9 cm) 27 MOA
<b>Overall Length:</b>	45" (114.3 cm)
<b>Barrel Length:</b>	29" Fluted (73.6 cm)
<b>Barrel Twist:</b>	1 in 15" (38.1 cm)
<b>Magazine Capacity:</b>	5

## FEATURES

- 1 | Compact, lightweight bullpup design
- 2 | Simplistic bolt carrier assembly with quick release lever
- 3 | Ergonomic bolt handle design
- 4 | Durable parkerized finish
- 5 | 11.25" (29.6 cm) 27 MOA M1913 optics rail
- 6 | Chrome-chambered 29" (73.6 cm) steel fluted barrel
- 7 | 3-port high efficiency muzzle brake
- 8 | 5-round steel magazine
- 9 | Accepts rear adjustable monopod
- 10 | Sorbothane® recoil pad

### Available Color



Black





# 240 LW & LWS

240LW & LWS







## LIGHT ON WEIGHT. HEAVY ON PERFORMANCE.

Our nation has been at war, on several fronts, for nearly two continuous decades. Among the multitude of lessons learned about firearms and equipment, the most universal can be summarized very simply: ounces equal pounds; pounds equal pain. Understanding that speed and agility are critical factors in winning a gunfight, Barrett took a fresh look at the combat-proven 240 machine gun; a firearm in service with American forces for the last 40 years. The end result of this exercise is the revolutionary 240LW & 240LWS family of machineguns.

Utilizing modern manufacturing techniques and materials, Barrett has brought this tried and true design into the 21st century, reducing system weight by over 25% compared to legacy models. The Barrett 240LW & 240LWS eliminate the original heavy receiver that is riveted together and prone to corrosion in favor of a forged design that is precision machined and welded. These efforts have reduced the overall weight of the 240LW by 5.5 pounds and the 240LWS by 6.6 pounds, and reduced total receiver parts count from 64 to just 2. No extra steel, no rivets to vibrate loose, no rare/exotic materials—just common sense and solid engineering. ■



240LW &amp; LWS







# 240LW

Though the [M240 machinegun](#) has been historically noted for its reliability, its weight has not gone unnoticed. By utilizing modern manufacturing techniques, Barrett has developed a notably lighter receiver. The result is the 20.15 lbs (9.1 kg) Barrett 240LW.



## FEATURES

- 1 | Folding rear sight
- 2 | Top cover design that remains in open position, even with optics mounted
- 3 | 7" (17.8 cm) M1913 optics rail
- 4 | Ammunition belt retaining feature that facilitates single operator loading
- 5 | Belt-fed using M13 links
- 6 | Receiver machined from forgings
- 7 | Carrying handle folds in both directions for use with optics
- 8 | Quick change barrel with 1 in 12" (30.5 cm) right hand rifling twist

- 9 | Folding front sight
- 10 | 3-position adjustable gas system
- 11 | Accessory rail mounting points
- 12 | Quick detach folding bipod
- 13 | Barrett Lightweight Handguard mounts on the receiver, not on the gas tube
- 14 | Barrett telescoping buttstock with adjustable length of pull and hydraulic buffer

### Available Colors



Black | Flat Dark Earth



# 240LWS

Taking the [240LW](#) a step further, the firing controls are moved forward and the buttstock is shortened. It packs the same punch as the 240LW but comes in a lighter, more maneuverable package.



## FEATURES

- 1 | Folding rear sight
- 2 | Top cover design that remains in open position, even with optics mounted
- 3 | 7" (17.8 cm) M1913 optics rail
- 4 | Ammunition belt retaining feature that facilitates single operator loading
- 5 | Belt-fed using M13 links
- 6 | Receiver machined from forgings
- 7 | Carrying handle folds in both directions for use with optics
- 8 | Quick change barrel with 1 in 12" (30.5 cm) right hand rifling twist

240LW &amp; LWS

- 9 | Folding front sight
- 10 | 3-position adjustable gas system
- 11 | Accessory rail mounting points
- 12 | Quick detach folding bipod
- 13 | Barrett Lightweight Handguard mounts on the receiver, not on the gas tube
- 14 | Barrett telescoping buttstock with adjustable length of pull and hydraulic buffer

### Available Colors



Black | Flat Dark Earth



## 240LW & LWS Configurations



### MODEL 240LW

Caliber	Operation	Barrel Length	Barrel Twist	Overall Length	Weight
7.62 x 51 mm NATO	Full-Auto	22.9" (58.2 cm)	1 in 12" (30.5 cm)	47" (119.4 cm)	20.9 lbs (9.4 kg)



### MODEL 240LWS

Caliber	Operation	Barrel Length	Barrel Twist	Overall Length	Weight
7.62 x 51 mm NATO	Full-Auto	18.9" (48.0 cm)	1 in 12" (30.5 cm)	43" (109.2 cm)	20.2 lbs (9.1 kg)

Ammunition belt retaining feature that facilitates single operator loading



240LW & LWS





ACCESSORIES



# AM & DC SUPPRESSOR SOUND IS JUST THE START

Sound suppression is only one metric by which suppressors are measured. While the [AM & DC suppressors](#) do offer world class decibel reduction, they also take into consideration other critical factors such as accuracy, point of impact shift, weight, and flash reduction.

The AM & DC suppressors are made of a lightweight, high strength Titanium alloy, which is 100% CNC machined and orbital welded to minimize weight without sacrificing durability. The suppressor bore is wire EDM cut for perfect concentricity to ensure rifle accuracy is not compromised and point of impact shift is both minimal and repeatable every time. Last but not least, for military and law enforcement customers, these suppressors are specifically engineered and tested to eliminate muzzle flash—even in low light environments. The AM30 & AM338 quickly attach to a recoil-reducing Barrett muzzle brake, whereas the DC30 & DC338 connect directly to your rifle threads for the ultimate in simplicity. Whichever you choose, rest assured that your rounds will be on target when it counts.

### Available Colors



Black | Flat Dark Earth | Natural Titanium

### SPECS

Model	Caliber	Length	Diameter	Weight	Sound Reduction	Mount & Thread Pitch
AM 30	30 and less	8.3" (21.1 cm)	1.50" (3.8 cm)	.775 lbs (0.4 kg)	-25-30 dB	Barrett® Muzzle Brake Adaptor: 5/8 x 24
DC 30	30 and less	8.3" (21.1 cm)	1.50" (3.8 cm)	.775 lbs (0.4 kg)	-25-30 dB	Direct Thread: 5/8 x 24
AM 338	338 and less	9.9" (25.2 cm)	1.75" (4.5 cm)	1.29 lbs (0.7 kg)	-23-28 dB	Barrett® Muzzle Brake Adaptor: 3/4 x 24
DC 338	338 and less	9.9" (25.2 cm)	1.75" (4.5 cm)	1.42 lbs (0.6 kg)	-23-28 dB	Direct Thread: 3/4 x 24



The AM30 & AM338 quickly attach to the Barrett muzzle brake



# QDL SUPPRESSOR BIG BORE SIGNATURE REDUCTION.

The 50 BMG has been present on nearly every battlefield in every war fought in the last 100 years. Its raw power has become a staple of American and allied fighting forces, but it took Barrett ingenuity to transform this machinegun cartridge into a viable option for long-range sniper and anti-material shoulder fired rifles. The [QDL suppressor](#) takes this capability one step further, adding not only sound, but also signature reduction to the platform.

Specifically engineered for the M107A1, Model 99, and Model 95, the QDL attaches to the rifle via proprietary recoil reducing muzzle brake, and maintains 100% function and reliability. The baffle stack features redundant 360 degree CNC welds to contain the extreme pressures, while the suppressor's dual-layered tube is constructed of high strength alloys to ensure both durability and safety in any condition. In another industry first, the QDL incorporates a ported recoil reducing brake that can be easily removed when muzzle flash is a priority. Simply slide the suppressor over the muzzle brake and twist the lock-ring—perfect alignment every time. Guaranteed.

### Available Colors



Black | Flat Dark Earth

### SPECS

<b>Model:</b>	Barrett QDL Suppressor
<b>Caliber:</b>	50 BMG
<b>Length Added:</b>	12.73" (32.2 cm)
<b>Diameter:</b>	2.5" (6.4 cm)
<b>Length:</b>	14.84" (37.7 cm) without detachable auxiliary muzzle brake
<b>Weight:</b>	4.88 lbs (2.2 kg)
<b>Finish :</b>	Black or FDE Cerakote
<b>Total Decibel Reduction:</b>	23 dB
<b>Mount:</b>	Quick Detach 1/4 Turn Lock Ring
<b>Materials:</b>	4130 Steel





# ZERO-GAP® RINGS SEAMLESS PERFECTION.

Unlike traditional scope rings which require careful attention be paid to maintaining equal gap between the upper and lower ring halves, Barrett's ZERO-GAP technology eliminates this tedious process. Simply tighten the cap on the indicated side, verify reticle alignment, tighten the remaining side, and fire away. The end result is a perfect fit between scope and mount that will withstand even the heaviest recoiling rifles. Machined from 7075-T5 aluminum and with MIL-SPEC Type III anodized finish, [ZERO-GAP Rings](#) are available in a variety of heights for both 30mm, 34mm, and 35mm optics. Simplicity at its finest.

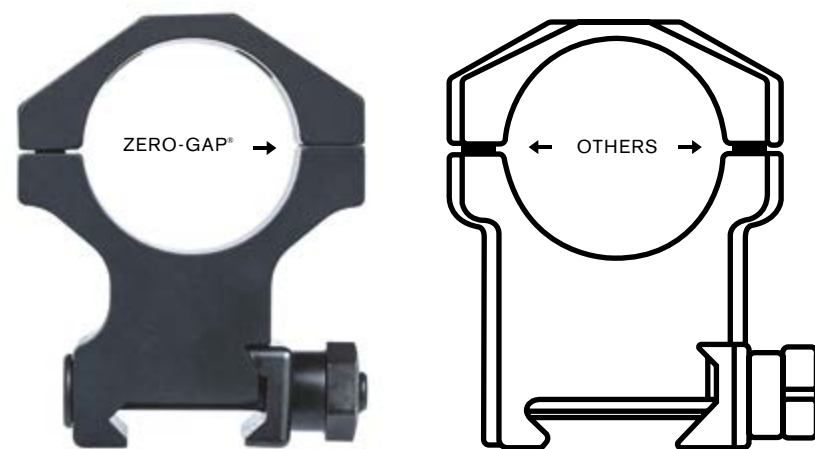

## SPECS

<b>Weight:</b>	8.32oz (235.9g), 8.5oz (239.6g)
<b>Size:</b>	30 mm, 34 mm
<b>Base Type:</b>	Mil-STD M1913 Rail
<b>Tensile Strength:</b>	83 ksi
<b>Ring Width:</b>	1.2" (3.1 cm)
<b>Surface Gripping Area:</b>	8.192 inch <sup>2</sup>
<b>Material:</b>	7075 T-6 Aluminum
<b>Finish:</b>	Hard Anodized Black
<b>Height:</b>	1.0"-1.7"

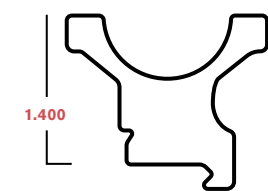

### ULTRA HIGH

Up to **56mm** objective with lens cover and extended scope rail.

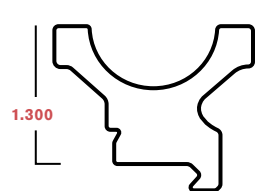

### HIGH

Up to **50mm** objective with lens cover and extended scope rail.

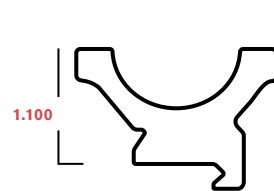

### MEDIUM

Up to **40mm** objective with lens cover and extended scope rail.

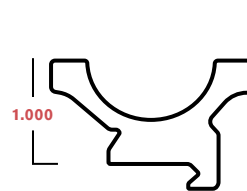

### LOW

Up to **30mm** objective or smaller caliber rifles and 6"-7" scope rails.

# TRAINING COURSES

Barrett's training department is ready to take you to the next level. Learn the intricacies of long-range shooting and maintain your Barrett rifles at an armorer level. Offering long-range shooting courses at locations around the country, as well as armorer courses at its Murfreesboro, Tennessee, factory, Barrett has the course to fit your large-caliber training needs. Call **615.896.2938** for tuition details.

## 82A1/ M107 ARMORER

The [82A1 / M107 Armorer Course](#) covers all 82 Series rifles. The two-day (16 hr) course covers troubleshooting and in-depth maintenance procedures. Upon successful completion of the course, each student is presented with a certification which is valid for three years. Mobile training available upon request.

## MRAD ARMORER

This [one-day \(8 hr\) course is geared toward MRAD® owners](#), law enforcement and military personnel, and gunsmiths. It covers depot level maintenance to keep these Barrett bolt action rifles in top operating condition. The course covers troubleshooting and in-depth maintenance procedures for MRAD® rifles. Upon successful completion of the course, each student is presented with a manufacturer certification of completion which is valid for three years.

## REC7 ARMORER

The [REC7 / M468 Armorer Course](#) covers all Barrett direct impingement and piston driven AR style rifles over a two day (16 hr) period of instruction. The course covers operation, troubleshooting, and in-depth maintenance procedures. Upon successful completion of the course and the final exercise, each student is presented with a certification of being qualified as a Barrett Certified Armorer, valid for three years.

## REC7 OPERATORS

The Barrett two-day [REC7 Operators Course](#) teaches you the necessary fundamentals needed to employ semi-automatic rifles safely, efficiently, and with enthusiasm for shooting sports. Learn the operational aspects of the rifle system to thorough cleaning and lubrication as well as safely and effectively engaging targets at extended ranges.

## MODEL 95/99 ARMORER

This [one-day \(8 hr\) course](#) is geared toward gun owners, gunsmiths, law enforcement and military personnel. It covers everything needed to keep Barrett bolt action rifles in top operating condition. The course covers troubleshooting and in-depth maintenance procedures for the Model 95 and Model 99™ rifles. Upon successful completion of the course, each student is presented with a certification which is valid for three years.

## LONG RANGE I

[Long Range I is a three-day \(24 hr\) course](#) that teaches shooters the fundamentals of marksmanship and introduces components of successful long range shooting including wind estimation, ballistics, and data collection. Long Range I is a learning experience for both the new and experienced shooters. Finish the course with a chance to hit the 10 ring at 1000 yards.

## LONG RANGE II

[Long Range II](#) is a three-day (24 hr) course taught exclusively at the NRA Whittington Center; students will be paired into shooter / spotter teams. After warming up on the 1000 yard known distance range, be prepared for the challenges of shooting on the unknown distance range at distances exceeding 1500 yards. Long Range I is a prerequisite for this course.

## PRECISION RIFLE

[Barrett Firearms Precision Rifle training](#) is a commemorative teaching method using lessons learned from marksmen and snipers throughout history. You are expected to have a high level of basic knowledge of firearms, long range marksmanship skills, and abilities to make long range precision rifle shots. This course will provide you with additional instruction in areas we feel are crucial to your weapons serviceability, long term maintenance, and success as a precision marksman.

## REC7 BUILD

Do you want the chance to build your own Barrett Rifle? [This Course covers the full assembly process of Barrett REC7® GEN II gas piston and direct impingement rifles](#) over a one day (8 hr) period of instruction. You will be instructed on the complete assembly and maintenance of your personal rifle. This course also covers dry-fire operation, troubleshooting, repair, and operator maintenance procedures. Upon successful completion of the course, each student will be presented with a certificate of conformance for a Barrett factory built REC7® Gen II to go along with your personal rifle.

Call **615.896.2938** for tuition details, or visit us at **Barrett.net**



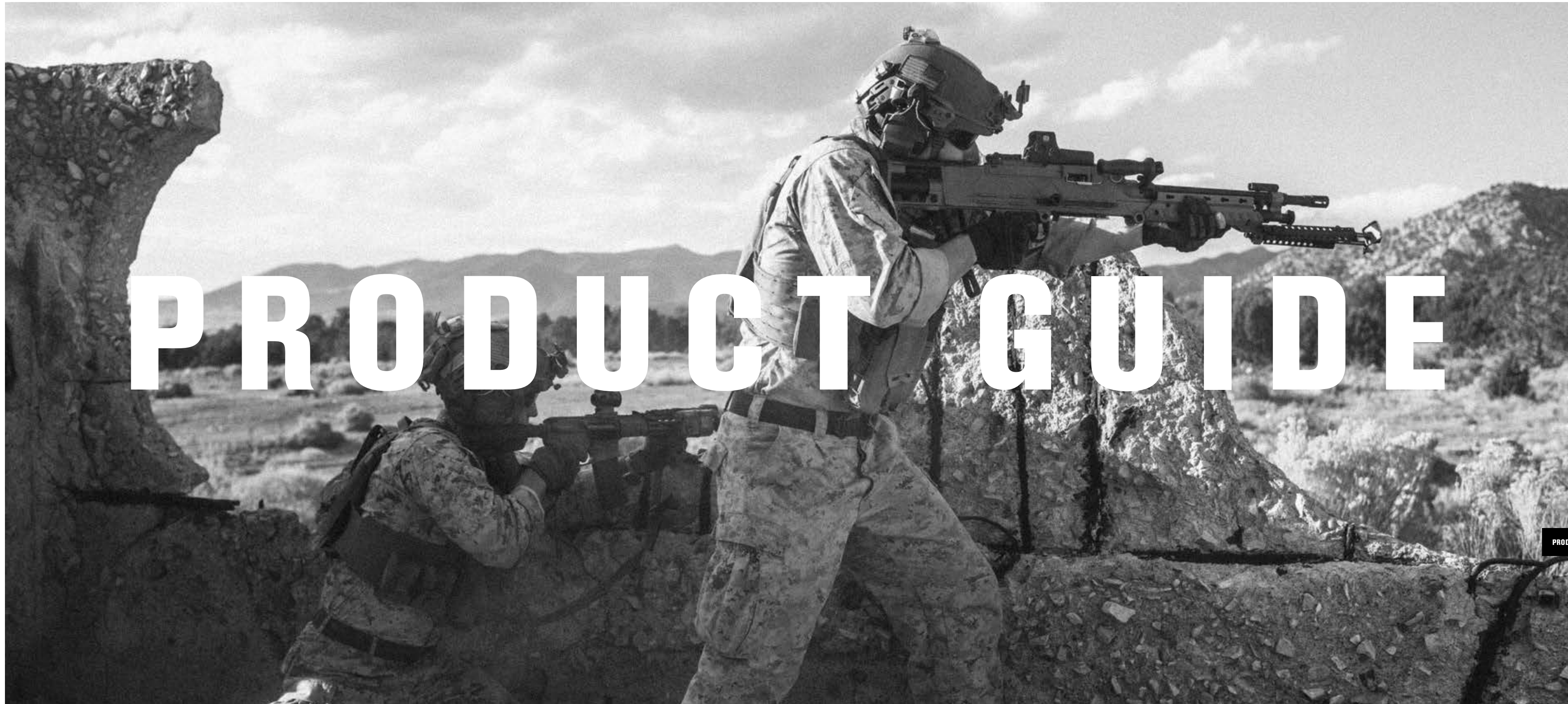



PRODUCT GUIDE  
**M107A1**<sup>®</sup>

## PRODUCTS

Part #	UPC	Caliber	Color/Finish	Barrel Length	Barrel Twist	Weight	Overall Length	Retail
14084	816715012425	50 BMG	Black Cerakote™	20" Fluted	1 turn in 15" (381 mm)	27.4 lbs (12.4 kg)	48" (1220 mm)	\$12,281
14016	816715012715	50 BMG	Black Cerakote™	20" Fluted	1 turn in 15" (381 mm)	27.4 lbs (12.4 kg)	48" (1220 mm)	\$13,694
14085	816715012432	50 BMG	Black Cerakote™	29" Fluted	1 turn in 15" (381 mm)	28.7 lbs (13 kg)	57" (1450 mm)	\$12,281
14018	816715012692	50 BMG	Black Cerakote™	29" Fluted	1 turn in 15" (381 mm)	28.7 lbs (13 kg)	57" (1450 mm)	\$13,694
14558	816715013071	50 BMG	Flat Dark Earth Cerakote™	20" Black Fluted	1 turn in 15" (381 mm)	27.4 lbs (12.4 kg)	48" (1220 mm)	\$12,281
14559	816715013088	50 BMG	Flat Dark Earth Cerakote™	29" Black Fluted	1 turn in 15" (381 mm)	28.7 lbs (13 kg)	57" (1450 mm)	\$12,281
14554	816715013033	50 BMG	OD Green Cerakote™	20" Black Fluted	1 turn in 15" (381 mm)	27.4 lbs (12.4 kg)	48" (1220 mm)	\$12,281
14555	816715013040	50 BMG	OD Green Cerakote™	29" Black Fluted	1 turn in 15" (381 mm)	28.7 lbs (13 kg)	57" (1450 mm)	\$12,281
14552	816715013019	50 BMG	Tungsten Grey Cerakote™	20" Black Fluted	1 turn in 15" (381 mm)	27.4 lbs (12.4 kg)	48" (1220 mm)	\$12,281
14553	816715013026	50 BMG	Tungsten Grey Cerakote™	29" Black Fluted	1 turn in 15" (381 mm)	28.7 lbs (13 kg)	57" (1450 mm)	\$12,281

## ACCESSORIES & PARTS

Part #	Description	UPC	Retail
12075	Magazine, Flat Dark Earth, 50 BMG, Witness Holes, 10 Round	816715010711	\$179
12808	Magazine, Black, 50 BMG, Witness Holes, 10 Round	816715012449	\$179
12774	QDL Suppressor (NFA Item), Black, Up to 50 BMG	816715010674	\$2,978
12364	QDL Suppressor (NFA Item), Flat Dark Earth, Up to 50 BMG	816715010667	\$2,978
13347	Barrett Soft Mount (Mounts rifle to any mil-spec pintle socket)	816715010698	\$1,080
13564	Monopod Kit, Tan, Lightweight	816715010889	\$154
13328	Spare Kit: Trigger Housing Pin, Bolt Carrier Pin, Extractor, Extractor Spring, Extractor Plunger, Rear Pin P Assembly & Midlock Pin Assembly.	816715011466	\$162
12580	Non-Rotating Buffer Assembly	816715010735	\$348
13390	Accessory Side Rails Kit (two 4.5" rails with screws)	816715012029	\$173



## PRODUCT GUIDE

**MODEL 82A1®****PRODUCTS**

Part #	UPC	Caliber	Color/Finish	Barrel Length	Barrel Twist	Weight	Overall Length	Retail
13318	816715010193	50 BMG	Manganese Phosphate Receiver	20" Fluted Barrel	1 turn in 15" (381 mm)	31.5 lbs (14 kg)	48" (1220 mm)	\$9,119
13123	816715011824	50 BMG Rifle Systems	Manganese Phosphate Receiver	20" Fluted Barrel	1 turn in 15" (381 mm)	31.5 lbs (14 kg)	48" (1220 mm)	\$10,532
13124	816715011831	50 BMG	Manganese Phosphate Receiver	20" Fluted Barrel	1 turn in 15" (381 mm)	31.5 lbs (14 kg)	48" (1220 mm)	\$11,958
13316	816715010025	50 BMG	Manganese Phosphate Receiver	29" Fluted Barrel	1 turn in 15" (381 mm)	32.7 lbs (14.8 kg)	57" (1450 mm)	\$9,119
13317	816715010018	50 BMG	Manganese Phosphate Receiver	29" Fluted Barrel	1 turn in 15" (381 mm)	32.7 lbs (14.8 kg)	57" (1450 mm)	\$10,532
14030	816715012647	50 BMG	Flat Dark Earth Cerakote™	20" Fluted Barrel	1 turn in 15" (381 mm)	31.5 lbs (14 kg)	48" (1220 mm)	\$9,323
14022	816715012630	50 BMG	Flat Dark Earth Cerakote™	20" Fluted Barrel	1 turn in 15" (381 mm)	31.5 lbs (14 kg)	48" (1220 mm)	\$10,736
14031	816715012616	50 BMG	Flat Dark Earth Cerakote™	29" Fluted Barrel	1 turn in 15" (381 mm)	32.7 lbs (14.8 kg)	57" (1450 mm)	\$9,323
14024	816715012609	50 BMG	Flat Dark Earth Cerakote™	29" Fluted Barrel	1 turn in 15" (381 mm)	32.7 lbs (14.8 kg)	57" (1450 mm)	\$10,736
13315	816715011404	416 Barrett	Manganese Phosphate Receiver	29" Fluted Barrel	1 turn in 12" (305 mm)	32.7 lbs (14.8 kg)	57" (1450 mm)	\$9,119
13137	816715011626	416 Barrett	Manganese Phosphate Receiver	29" Fluted Barrel	1 turn in 12" (305 mm)	32.7 lbs (14.8 kg)	57" (1450 mm)	\$10,532
17462	816715017666	416 Barrett	Manganese Phosphate Receiver	Compliant 29" Fluted Barrel	1 turn in 12" (305 mm)	32.7 lbs (14.8 kg)	57" (1450 mm)	\$9,259
14029	816715012678	416 Barrett	Flat Dark Earth Cerakote™	29" Fluted Barrel	1 turn in 12" (305 mm)	32.7 lbs (14.8 kg)	57" (1450 mm)	\$9,323
14020	816715012661	416 Barrett	Flat Dark Earth Cerakote™	29" Fluted Barrel	1 turn in 12" (305 mm)	32.7 lbs (14.8 kg)	57" (1450 mm)	\$10,736
17463	816715017673	416 Barrett	Flat Dark Earth Cerakote™	Compliant 29" Fluted Barrel	1 turn in 12" (305 mm)	32.7 lbs (14.8 kg)	57" (1450 mm)	\$9,463
17464	816715017680	416 Barrett	Burnt Bronze Cerakote Receiver	Compliant 29" Fluted Barrel	1 turn in 12" (305 mm)	32.7 lbs (14.8 kg)	57" (1450 mm)	\$9,463
17465	816715017697	416 Barrett	Tungsten Grey Cerakote Receiver	Compliant 29" Fluted Barrel	1 turn in 12" (305 mm)	32.7 lbs (14.8 kg)	57" (1450 mm)	\$9,463
17466	816715017703	416 Barrett	OD Green Cerakote Receiver	Compliant 29" Fluted Barrel	1 turn in 12" (305 mm)	32.7 lbs (14.8 kg)	57" (1450 mm)	\$9,463

**ACCESSORIES & PARTS**

Part #	UPC	Description	Retail
12649	816715010490	Upper, 416 Barrett, Manganese Phosphate Receiver, 29" Fluted Barrel	\$4,967
14026	816715012586	Upper, 416 Barrett, Flat Dark Earth Receiver, 29" Fluted Barrel	\$5,069
12660	816715010513	Upper, 50 BMG, Manganese Phosphate Receiver, 20" Fluted Barrel	\$4,967
12650	816715010506	Upper, 50 BMG, Manganese Phosphate Receiver, 29" Fluted Barrel	\$4,967
14027	816715012579	Upper, 50 BMG, Flat Dark Earth Receiver, 20" Fluted Barrel	\$5,069
14028	816715012562	Upper, 50 BMG, Flat Dark Earth Receiver, 29" Fluted Barrel	\$5,069
13355	816715010957	Magazine, Black, 50 BMG, 10 Round	\$158
82440	816715010728	Magazine, Black, 416 Barrett, 10 Round	\$158
13347	816715010698	Barrett Soft Mount (Mounts rifle to any mil-spec pintle socket)	\$1,080
13351	816715010919	Bipod Assembly, Black, Spiked Feet	\$308
13348	816715011022	Monopod Kit, Black (Must Have Monopod Socket)	\$152
13328	816715011466	Spare Kit: Trigger Housing Pin, Bolt Carrier Pin, Extractor, Extractor Spring, Extractor Plunger, Rear Pin Assembly & Midlock Pin Assembly.	\$162
13333	816715010155	Accessory Side Rails Kit (two 4.5" rails with screws)	\$173



## PRODUCT GUIDE

**MRAD**<sup>®</sup>**PRODUCTS**

Part #	UPC	Caliber	Color/Finish	Barrel Length	Barrel Twist	Weight	Overall Length	Retail
14352	816715013514	338 Lapua Magnum	Black Anodized	20" Heavy Barrel	1 in 9.4" (240 mm)	12.9 lbs (5.9 kg)	43.4" (1102 mm)	\$6,000
14353	816715013521	338 Lapua Magnum	Black Anodized	20" Fluted Barrel	1 in 9.4" (240 mm)	12.8 lbs (5.8 kg)	43.4" (1102 mm)	\$6,154
14354	816715013538	338 Lapua Magnum	Black Anodized	24" Heavy Barrel	1 in 9.4" (240 mm)	13.9 lbs (6.3 kg)	47.4" (1204 mm)	\$6,000
14355	816715013545	338 Lapua Magnum	Black Anodized	24" Fluted Barrel	1 in 9.4" (240 mm)	13.8 lbs (6.3 kg)	47.4" (1204 mm)	\$6,154
15485	816715015204	338 Lapua Magnum	Black Anodized	24" Carbon Fiber Barrel	1 in 9.4" (240 mm)	12.7 lbs (5.74 kg)	47.4" (1204 mm)	\$6,975
14356	816715013552	338 Lapua Magnum	Black Anodized	26" Heavy Barrel	1 in 9.4" (240 mm)	14.5 lbs (6.6 kg)	49.4" (1255 mm)	\$6,000
14357	816715013569	338 Lapua Magnum	Black Anodized	26" Fluted Barrel	1 in 9.4" (240 mm)	14.4 lbs (6.6 kg)	49.4" (1255 mm)	\$6,154
14383	816715013750	338 Lapua Magnum	Tungsten Grey Cerakote™	20" Heavy Barrel	1 in 9.4" (240 mm)	12.9 lbs (5.9 kg)	43.4" (1102 mm)	\$6,000
14384	816715013161	338 Lapua Magnum	Tungsten Grey Cerakote™	20" Fluted Barrel	1 in 9.4" (240 mm)	12.8 lbs (5.8 kg)	43.4" (1102 mm)	\$6,154
14385	816715013774	338 Lapua Magnum	Tungsten Grey Cerakote™	24" Heavy Barrel	1 in 9.4" (240 mm)	13.9 lbs (6.3 kg)	47.4" (1204 mm)	\$6,000
14386	816715013781	338 Lapua Magnum	Tungsten Grey Cerakote™	24" Fluted Barrel	1 in 9.4" (240 mm)	13.8 lbs (6.3 kg)	47.4" (1204 mm)	\$6,154
15489	816715015242	338 Lapua Magnum	Tungsten Grey Cerakote™	24" Carbon Fiber Barrel	1 in 9.4" (240 mm)	12.7 lbs (5.7 kg)	47.4" (1204 mm)	\$6,975
14387	816715013798	338 Lapua Magnum	Tungsten Grey Cerakote™	26" Heavy Barrel	1 in 9.4" (240 mm)	14.5 lbs (6.6 kg)	49.4" (1255 mm)	\$6,000
14388	816715013804	338 Lapua Magnum	Tungsten Grey Cerakote™	26" Fluted Barrel	1 in 9.4" (240 mm)	14.4 lbs (6.6 kg)	49.4" (1255 mm)	\$6,154
14377	816715013699	338 Lapua Magnum	OD Green Cerakote™	20" Heavy Barrel	1 in 9.4" (240 mm)	12.9 lbs (5.9 kg)	43.4" (1102 mm)	\$6,000
14378	816715013705	338 Lapua Magnum	OD Green Cerakote™	20" Fluted Barrel	1 in 9.4" (240 mm)	12.8 lbs (5.8 kg)	43.4" (1102 mm)	\$6,154
14379	816715013712	338 Lapua Magnum	OD Green Cerakote™	24" Heavy Barrel	1 in 9.4" (240 mm)	13.9 lbs (6.3 kg)	47.4" (1204 mm)	\$6,000
14380	816715013729	338 Lapua Magnum	OD Green Cerakote™	24" Fluted Barrel	1 in 9.4" (240 mm)	13.8 lbs (6.3 kg)	47.4" (1204 mm)	\$6,154
15488	816715015235	338 Lapua Magnum	OD Green Cerakote™	24" Carbon Fiber Barrel	1 in 9.4" (240 mm)	12.6 lbs (5.7 kg)	47.4" (1204 mm)	\$6,975
14381	816715013736	338 Lapua Magnum	OD Green Cerakote™	26" Heavy Barrel	1 in 9.4" (240 mm)	14.5 lbs (6.6 kg)	49.4" (1255 mm)	\$6,000
14382	816715013743	338 Lapua Magnum	OD Green Cerakote™	26" Fluted Barrel	1 in 9.4" (240 mm)	14.4 lbs (6.6 kg)	49.4" (1255 mm)	\$6,154

Part #	UPC	Caliber	Color/Finish	Barrel Length	Barrel Twist	Weight	Overall Length	Retail
14371	816715013637	338 Lapua Magnum	Flat Dark Earth Cerakote™	20" Heavy Barrel	1 in 9.4" (240 mm)	12.9 lbs (5.8 kg)	43.4" (1102 mm)	\$6,000
14372	816715013644	338 Lapua Magnum	Flat Dark Earth Cerakote™	20" Fluted Barrel	1 in 9.4" (240 mm)	12.8 lbs (5.8 kg)	43.4" (1102 mm)	\$6,154
14373	816715013651	338 Lapua Magnum	Flat Dark Earth Cerakote™	24" Heavy Barrel	1 in 9.4" (240 mm)	13.9 lbs (6.3 kg)	47.4" (1204 mm)	\$6,000
14374	816715013668	338 Lapua Magnum	Flat Dark Earth Cerakote™	24" Fluted Barrel	1 in 9.4" (240 mm)	13.8 lbs (6.3 kg)	47.4" (1204 mm)	\$6,154
15487	816715015228	338 Lapua Magnum	Flat Dark Earth Cerakote™	24" Carbon Fiber Barrel	1 in 9.4" (240 mm)	12.7 lbs (5.7 kg)	47.4" (1204 mm)	\$6,975
14375	816715013675	338 Lapua Magnum	Flat Dark Earth Cerakote™	26" Heavy Barrel	1 in 9.4" (240 mm)	14.5 lbs (6.6 kg)	49.4" (1255 mm)	\$6,000
14376	816715013682	338 Lapua Magnum	Flat Dark Earth Cerakote™	26" Fluted Barrel	1 in 9.4" (240 mm)	14.4 lbs (6.6 kg)	49.4" (1255 mm)	\$6,154
16305	816715016850	338 Lapua Magnum	Burnt Bronze Cerakote™	20" Heavy Barrel	1 in 9.4" (240 mm)	12.9 lbs (5.9 kg)	43.4" (1102 mm)	\$6,000
16306	816715016867	338 Lapua Magnum	Burnt Bronze Cerakote™	20" Fluted Barrel	1 in 9.4" (240 mm)	12.8 lbs (5.8 kg)	43.4" (1102 mm)	\$6,154
16307	816715016874	338 Lapua Magnum	Burnt Bronze Cerakote™	24" Heavy Barrel	1 in 9.4" (240 mm)	13.9 lbs (6.3 kg)	47.4" (1204 mm)	\$6,000
16308	816715016881	338 Lapua Magnum	Burnt Bronze Cerakote™	24" Fluted Barrel	1 in 9.4" (240 mm)	13.8 lbs (6.3 kg)	47.4" (1204 mm)	\$6,154
16325	816715016898	338 Lapua Magnum	Burnt Bronze Cerakote™	24" Carbon Fiber Barrel	1 in 9.4" (240 mm)	12.7 lbs (5.7 kg)	47.4" (1204 mm)	\$6,975
16309	816715016904	338 Lapua Magnum	Burnt Bronze Cerakote™	26" Heavy Barrel	1 in 9.4" (240 mm)	14.5 lbs (6.6 kg)	49.4" (1255 mm)	\$6,000
16310	816715016911	338 Lapua Magnum	Burnt Bronze Cerakote™	26" Fluted Barrel	1 in 9.4" (240 mm)	14.4 lbs (6.6 kg)	49.4" (1255 mm)	\$6,154
14360	816715013354	300 Winchester Magnum	Black Anodized	24" Heavy Barrel	1 in 10" (250 mm)	13.4 lbs (6.1 kg)	47.4" (1204 mm)	\$6,000
14361	816715013361	300 Winchester Magnum	Black Anodized	24" Fluted Barrel	1 in 10" (250 mm)	13.3 lbs (6.0 kg)	47.4" (1204 mm)	\$6,154
15490	816715015259	300 Winchester Magnum	Black Anodized	24" Carbon Fiber Barrel	1 in 10" (250 mm)	12.2 lbs (5.5 kg)	47.4" (1204 mm)	\$6,975
14393	816715013439	300 Winchester Magnum	Tungsten Grey Cerakote™	24" Heavy Barrel	1 in 10" (250 mm)	13.4 lbs (6.1 kg)	47.4" (1204 mm)	\$6,000
14394	816715013446	300 Winchester Magnum	Tungsten Grey Cerakote™	24" Fluted Barrel	1 in 10" (250 mm)	13.3 lbs (6.0 kg)	47.4" (1204 mm)	\$6,154

PRODUCT GUIDE



MRAD | PRODUCTS CONTINUED

Part #	UPC	Caliber	Color/Finish	Barrel Length	Barrel Twist	Weight	Overall Length	Retail
15494	816715015297	300 Winchester Magnum	Tungsten Grey Cerakote™	24" Carbon Fiber Barrel	1 in 10" (250 mm)	12.2 lbs (5.5 kg)	47.4" (1204 mm)	\$6,975
14391	816715013415	300 Winchester Magnum	OD Green Cerakote™	24" Heavy Barrel	1 in 10" (250 mm)	13.4 lbs (6.1 kg)	47.4" (1204 mm)	\$6,000
14392	816715013422	300 Winchester Magnum	OD Green Cerakote™	24" Fluted Barrel	1 in 10" (250 mm)	13.3 lbs (6.0 kg)	47.4" (1204 mm)	\$6,154
15493	816715015280	300 Winchester Magnum	OD Green Cerakote™	24" Carbon Fiber Barrel	1 in 10" (250 mm)	12.2 lbs (5.5 kg)	47.4" (1204 mm)	\$6,975
14389	816715013392	300 Winchester Magnum	Flat Dark Earth Cerakote™	24" Heavy Barrel	1 in 10" (250 mm)	13.4 lbs (6.1 kg)	47.4" (1204 mm)	\$6,000
14390	816715013408	300 Winchester Magnum	Flat Dark Earth Cerakote™	24" Fluted Barrel	1 in 10" (250 mm)	13.3 lbs (6.0 kg)	47.4" (1204 mm)	\$6,154
15492	816715015273	300 Winchester Magnum	Flat Dark Earth Cerakote™	24" Carbon Fiber Barrel	1 in 10" (250 mm)	12.2 lbs (5.5 kg)	47.4" (1204 mm)	\$6,975
16311	816715016829	300 Winchester Magnum	Burnt Bronze Cerakote™	24" Heavy Barrel	1 in 10" (250 mm)	13.4 lbs (6.1 kg)	47.4" (1204 mm)	\$6,000
16312	816715016836	300 Winchester Magnum	Burnt Bronze Cerakote™	24" Fluted Barrel	1 in 10" (250 mm)	13.3 lbs (6.0 kg)	47.4" (1204 mm)	\$6,154
16326	816715016843	300 Winchester Magnum	Burnt Bronze Cerakote™	24" Carbon Fiber Barrel	1 in 10" (250 mm)	12.2 lbs (5.5 kg)	47.4" (1204 mm)	\$6,975
15463	816715015402	7mm Remington Magnum	Black Anodized	24" Heavy Barrel	1 in 8.5" (210 mm)	13.4 lbs (6.1 kg)	47.4" (1204 mm)	\$6,000
15468	816715015419	7mm Remington Magnum	Black Anodized	24" Fluted Barrel	1 in 8.5" (210 mm)	13.3 lbs (6.0 kg)	47.4" (1204 mm)	\$6,154
15467	816715015488	7mm Remington Magnum	Tungsten Grey Cerakote™	24" Heavy Barrel	1 in 8.5" (210 mm)	13.4 lbs (6.1 kg)	47.4" (1204 mm)	\$6,000
15472	816715015495	7mm Remington Magnum	Tungsten Grey Cerakote™	24" Fluted Barrel	1 in 8.5" (210 mm)	13.3 lbs (6.0 kg)	47.4" (1204 mm)	\$6,154
15466	816715015464	7mm Remington Magnum	OD Green Cerakote™	24" Heavy Barrel	1 in 8.5" (210 mm)	13.4 lbs (6.1 kg)	47.4" (1204 mm)	\$6,000
15471	816715015471	7mm Remington Magnum	OD Green Cerakote™	24" Fluted Barrel	1 in 8.5" (210 mm)	13.3 lbs (6.0 kg)	47.4" (1204 mm)	\$6,154
15465	816715015440	7mm Remington Magnum	Flat Dark Earth Cerakote™	24" Heavy Barrel	1 in 8.5" (210 mm)	13.4 lbs (6.1 kg)	47.4" (1204 mm)	\$6,000

Part #	UPC	Caliber	Color/Finish	Barrel Length	Barrel Twist	Weight	Overall Length	Retail
15470	816715015457	7mm Remington Magnum	Flat Dark Earth Cerakote™	24" Fluted Barrel	1 in 8.5" (210 mm)	13.3 lbs (6.0 kg)	47.4" (1204 mm)	\$6,154
16321	816715016805	7mm Remington Magnum	Burnt Bronze Cerakote™	24" Heavy Barrel	1 in 8.5" (210 mm)	13.4 lbs (6.1 kg)	47.4" (1204 mm)	\$6,000
16322	816715016812	7mm Remington Magnum	Burnt Bronze Cerakote™	24" Fluted Barrel	1 in 8.5" (210 mm)	13.3 lbs (6.0 kg)	47.4" (1204 mm)	\$6,154
14342	816715012913	308 Winchester	Black Anodized	17" Heavy Barrel	1 in 10" (250 mm)	11.7 lbs (5.3 kg)	40.4" (1026 mm)	\$6,000
15475	816715015105	308 Winchester	Black Anodized	17" Carbon Fiber Barrel	1 in 10" (250 mm)	11.4 lbs (5.2 kg)	40.4" (1026 mm)	\$6,975
14345	816715012920	308 Winchester	Black Anodized	22" Fluted Barrel	1 in 10" (250 mm)	13.0 lbs (5.9 kg)	45.4" (1153 mm)	\$6,154
15480	816715015150	308 Winchester	Black Anodized	22" Carbon Fiber Barrel	1 in 10" (250 mm)	11.9 lbs (5.4 kg)	45.4" (1153 mm)	\$6,975
14368	816715012999	308 Winchester	Tungsten Grey Cerakote™	17" Heavy Barrel	1 in 10" (250 mm)	11.7 lbs (5.3 kg)	40.4" (1026 mm)	\$6,000
15479	816715015143	308 Winchester	Tungsten Grey Cerakote™	17" Carbon Fiber Barrel	1 in 10" (250 mm)	11.4 lbs (5.2 kg)	40.4" (1026 mm)	\$6,975
14370	816715013002	308 Winchester	Tungsten Grey Cerakote™	22" Fluted Barrel	1 in 10" (250 mm)	13.0 lbs (5.9 kg)	45.4" (1153 mm)	\$6,154
15484	816715015198	308 Winchester	Tungsten Grey Cerakote™	22" Carbon Fiber Barrel	1 in 10" (250 mm)	12.0 lbs (5.4 kg)	45.4" (1153 mm)	\$6,975
14365	816715012975	308 Winchester	OD Green Cerakote™	17" Heavy Barrel	1 in 10" (250 mm)	11.7 lbs (5.3 kg)	40.4" (1026 mm)	\$6,000
15478	816715015136	308 Winchester	OD Green Cerakote™	17" Carbon Fiber Barrel	1 in 10" (250 mm)	11.4 lbs (5.2 kg)	40.4" (1026 mm)	\$6,975
14367	816715012982	308 Winchester	OD Green Cerakote™	22" Fluted Barrel	1 in 10" (250 mm)	13.0 lbs (5.9 kg)	45.4" (1153 mm)	\$6,154
15483	816715015181	308 Winchester	OD Green Cerakote™	22" Carbon Fiber Barrel	1 in 10" (250 mm)	12.0 lbs (5.4 kg)	45.4" (1153 mm)	\$6,975
14343	816715012951	308 Winchester	Flat Dark Earth Cerakote™	17" Heavy Barrel	1 in 10" (250 mm)	11.7 lbs (5.3 kg)	40.4" (1026 mm)	\$6,000
15477	816715015129	308 Winchester	Flat Dark Earth Cerakote™	17" Carbon Fiber Barrel	1 in 10" (250 mm)	11.4 lbs (5.2 kg)	40.4" (1026 mm)	\$6,975
14364	816715012968	308 Winchester	Flat Dark Earth Cerakote™	22" Fluted Barrel	1 in 10" (250 mm)	13.0 lbs (5.9 kg)	45.4" (1153 mm)	\$6,154
15482	816715015174	308 Winchester	Flat Dark Earth Cerakote™	22" Carbon Fiber Barrel	1 in 10" (250 mm)	12.0 lbs (5.4 kg)	45.4" (1153 mm)	\$6,975
16303	816715016706	308 Winchester	Burnt Bronze Cerakote™	17" Heavy Barrel	1 in 10" (250 mm)	11.7 lbs (5.3 kg)	40.4" (1026 mm)	\$6,000
16323	816715016713	308 Winchester	Burnt Bronze Cerakote™	17" Carbon Fiber Barrel	1 in 10" (250 mm)	11.4 lbs (5.2 kg)	40.4" (1026 mm)	\$6,975
16304	816715016720	308 Winchester	Burnt Bronze Cerakote™	22" Fluted Barrel	1 in 10" (250 mm)	13.0 lbs (5.9 kg)	45.4" (1153 mm)	\$6,154
16324	816715016737	308 Winchester	Burnt Bronze Cerakote™	22" Carbon Fiber Barrel	1 in 10" (250 mm)	12.0 lbs (5.4 kg)	45.4" (1153 cm)	\$6,975

PRODUCT GUIDE



MRAD | PRODUCTS CONTINUED

Part #	UPC	Caliber	Color/Finish	Barrel Length	Barrel Twist	Weight	Overall Length	Retail
14440	816715015624	6.5 Creedmoor	Black Anodized	24" Heavy Barrel	1 in 8" (200 mm)	13.3 lbs (6.0 kg)	47.4" (1204 mm)	\$6,000
14441	816715015631	6.5 Creedmoor	Black Anodized	24" Fluted Barrel	1 in 8" (200 mm)	13.2 lbs (5.9 kg)	47.4" (1204 mm)	\$6,154
15500	816715015358	6.5 Creedmoor	Black Anodized	24" Carbon Fiber Barrel	1 in 8" (200 mm)	12.3 lbs (5.6 kg)	47.4" (1204 mm)	\$6,975
14448	816715015709	6.5 Creedmoor	Tungsten Grey Cerakote™	24" Heavy Barrel	1 in 8" (200 mm)	13.3 lbs (6.0 kg)	47.4" (1204 mm)	\$6,000
14449	816715015716	6.5 Creedmoor	Tungsten Grey Cerakote™	24" Fluted Barrel	1 in 8" (200 mm)	13.2 lbs (5.9 kg)	47.4" (1204 mm)	\$6,154
15504	816715015396	6.5 Creedmoor	Tungsten Grey Cerakote™	24" Carbon Fiber Barrel	1 in 8" (200 mm)	12.3 lbs (5.6 kg)	47.4" (1204 mm)	\$6,975
14446	816715015686	6.5 Creedmoor	OD Green Cerakote™	24" Heavy Barrel	1 in 8" (200 mm)	13.3 lbs (6.0 kg)	47.4" (1204 mm)	\$6,000
14447	816715015693	6.5 Creedmoor	OD Green Cerakote™	24" Fluted Barrel	1 in 8" (200 mm)	13.2 lbs (5.9 kg)	47.4" (1204 mm)	\$6,154
15503	816715015389	6.5 Creedmoor	OD Green Cerakote™	24" Carbon Fiber Barrel	1 in 8" (200 mm)	12.3 lbs (5.58 kg)	47.4" (1204 mm)	\$6,975
14444	816715015662	6.5 Creedmoor	Flat Dark Earth Cerakote™	24" Heavy Barrel	1 in 8" (200 mm)	13.3 lbs (6.0 kg)	47.4" (1204 mm)	\$6,000
14445	816715015679	6.5 Creedmoor	Flat Dark Earth Cerakote™	24" Fluted Barrel	1 in 8" (200 mm)	13.2 lbs (5.9 kg)	47.4" (1204 mm)	\$6,154
15502	816715015372	6.5 Creedmoor	Flat Dark Earth Cerakote™	24" Carbon Fiber Barrel	1 in 8" (200 mm)	12.3 lbs (5.6 kg)	47.4" (1204 mm)	\$6,975
16319	816715016744	6.5 Creedmoor	Burnt Bronze Cerakote™	24" Heavy Barrel	1 in 8" (200 mm)	13.3 lbs (6.0 kg)	47.4" (1204 mm)	\$6,000
16320	816715016751	6.5 Creedmoor	Burnt Bronze Cerakote™	24" Fluted Barrel	1 in 8" (200 mm)	13.2 lbs (5.9 kg)	47.4" (1204 mm)	\$6,154
16328	816715016768	6.5 Creedmoor	Burnt Bronze Cerakote™	24" Carbon Fiber Barrel	1 in 8" (200 mm)	12.3 lbs (5.6 kg)	47.4" (1204 mm)	\$6,975
14430	816715015525	260 Remington	Black Anodized	24" Heavy Barrel	1 in 8" (200 mm)	13.3 lbs (6.0 kg)	47.4" (1204 mm)	\$6,000
14431	816715015532	260 Remington	Black Anodized	24" Fluted Barrel	1 in 8" (200 mm)	13.2 lbs (5.9 kg)	47.4" (1204 mm)	\$6,154
15495	816715015303	260 Remington	Black Anodized	24" Carbon Fiber Barrel	1 in 8" (200 mm)	12.3 lbs (5.6 kg)	47.4" (1204 mm)	\$6,975
14438	816715015600	260 Remington	Tungsten Grey Cerakote™	24" Heavy Barrel	1 in 8" (200 mm)	13.3 lbs (6.0 kg)	47.4" (1204 mm)	\$6,000
14439	816715015617	260 Remington	Tungsten Grey Cerakote™	24" Fluted Barrel	1 in 8" (200 mm)	13.2 lbs (5.9 kg)	47.4" (1204 mm)	\$6,154
15499	816715015341	260 Remington	Tungsten Grey Cerakote™	24" Carbon Fiber Barrel	1 in 8" (200 mm)	12.3 lbs (5.6 kg)	47.4" (1204 mm)	\$6,975
14436	816715015587	260 Remington	OD Green Cerakote™	24" Heavy Barrel	1 in 8" (200 mm)	13.3 lbs (6.0 kg)	47.4" (1204 mm)	\$6,000
14437	816715015594	260 Remington	OD Green Cerakote™	24" Fluted Barrel	1 in 8" (200 mm)	13.2 lbs (5.9 kg)	47.4" (1204 mm)	\$6,154
15498	816715015334	260 Remington	OD Green Cerakote™	24" Carbon Fiber Barrel	1 in 8" (200 mm)	12.3 lbs (5.6 kg)	47.4" (1204 mm)	\$6,975
14434	816715015563	260 Remington	Flat Dark Earth Cerakote™	24" Heavy Barrel	1 in 8" (200 mm)	13.3 lbs (6.0 kg)	47.4" (1204 mm)	\$6,000

Part #	UPC	Caliber	Color/Finish	Barrel Length	Barrel Twist	Weight	Overall Length	Retail
14435	816715015570	260 Remington	Flat Dark Earth Cerakote™	24" Fluted Barrel	1 in 8" (200 mm)	13.2 lbs (5.9 kg)	47.4" (1204 mm)	\$6,154
15497	816715015327	260 Remington	Flat Dark Earth Cerakote™	24" Carbon Fiber Barrel	1 in 8" (200 mm)	12.3 lbs (5.6 kg)	47.4" (1204 mm)	\$6,975
16317	816715016775	260 Remington	Burnt Bronze Cerakote™	24" Heavy Barrel	1 in 8" (200 mm)	13.3 lbs (6.02 kg)	47.4" (1204 mm)	\$6,000
16318	816715016782	260 Remington	Burnt Bronze Cerakote™	24" Fluted Barrel	1 in 8" (200 mm)	13.2 lbs (5.9 kg)	47.4" (1204 mm)	\$6,154
16327	816715016799	260 Remington	Burnt Bronze Cerakote™	24" Carbon Fiber Barrel	1 in 8" (200 mm)	12.3 lbs (5.6 kg)	47.4" (1204 mm)	\$6,975
16223	816715016645	338 Lapua Magnum	338 Lapua Magnum MRAD Military Deployment Kit	24" Fluted FDE Barrel	1 in 9.4" (240 mm)	13.8 lbs (6.3 kg)	47.4" (1204 mm)	\$18,792

ACCESSORIES & PARTS

Part #	UPC	Caliber	Barrel Length	Barrel Twist	Retail
14272	816715013149	338 Lapua Magnum Conversion Kits "A"	20" Fluted Barrel	1 in 9.4" (240 mm)	\$1,565
14273	816715013156	338 Lapua Magnum Conversion Kits "A"	20" Heavy Barrel	1 in 9.4" (240 mm)	\$1,565
14274	816715013163	338 Lapua Magnum Conversion Kits "A"	24" Fluted Barrel	1 in 9.4" (240 mm)	\$1,565
14275	816715013170	338 Lapua Magnum Conversion Kits "A"	24" Heavy Barrel	1 in 9.4" (240 mm)	\$1,565
15154	816715015044	338 Lapua Magnum Conversion Kits "A"	24" Carbon Fiber Barrel	1 in 9.4" (240 mm)	\$2,380
14276	816715013187	338 Lapua Magnum Conversion Kits "A"	26" Fluted Barrel	1 in 9.4" (240 mm)	\$1,565
14277	816715013194	338 Lapua Magnum Conversion Kits "A"	26" Heavy Barrel	1 in 9.4" (240 mm)	\$1,565
14278	816715014542	338 Norma Magnum Conversion Kits "A"	24" Fluted Barrel	1 in 9.4" (240 mm)	\$1,565
14279	816715014559	338 Norma Magnum Conversion Kits "A"	24" Heavy Barrel	1 in 9.4" (240 mm)	\$1,565
14280	816715014566	300 Norma Magnum Conversion Kits "A"	24" Fluted Barrel	1 in 10" (250 mm)	\$1,565
14281	816715014573	300 Norma Magnum Conversion Kits "A"	24" Heavy Barrel	1 in 10" (250 mm)	\$1,565
14282	816715013224	300 Winchester Magnum Conversion Kits "B"	24" Fluted Barrel	1 in 10" (250 mm)	\$1,565
14283	816715013231	300 Winchester Magnum Conversion Kits "B"	24" Heavy Barrel	1 in 10" (250 mm)	\$1,565
15155	816715015051	300 Winchester Magnum Conversion Kits "B"	24" Carbon Fiber Barrel	1 in 10" (250 mm)	\$2,380
15474	816715015518	7mm Remington Magnum Conversion Kits "B"	24" Fluted Barrel	1 in 8.5" (210 mm)	\$1,565



## MRAD | PRODUCTS CONTINUED

Part #	UPC	Caliber	Barrel Length	Barrel Twist	Retail
15473	816715015501	7mm Remington Magnum Conversion Kits "B"	24" Heavy Barrel	1 in 8.5" (210 mm)	\$1,565
14206	816715013200	308 Winchester Conversion Kits "C"	17" Heavy Barrel	1 in 10" (250 mm)	\$1,565
15157	816715015075	308 Winchester Conversion Kits "C"	17" Carbon Fiber Barrel	1 in 10" (250 mm)	\$2,380
13261	816715013217	308 Winchester Conversion Kits "C"	22" Fluted Barrel	1 in 10" (250 mm)	\$1,565
15156	816715015068	308 Winchester Conversion Kits "C"	22" Carbon Fiber Barrel	1 in 10" (250 mm)	\$2,380
14288	816715014481	6.5 Creedmoor Conversion Kits "C"	24" Fluted Barrel	1 in 8" (200 mm)	\$1,565
14289	816715014498	6.5 Creedmoor Conversion Kits "C"	24" Heavy Barrel	1 in 8" (200 mm)	\$1,565
15159	816715015099	6.5 Creedmoor Conversion Kits "C"	24" Carbon Fiber Barrel	1 in 8" (200 mm)	\$2,380
14286	816715014467	260 Remington Conversion Kits "C"	24" Fluted Barrel	1 in 8" (200 mm)	\$1,565
14287	816715014474	260 Remington Conversion Kits "C"	24" Heavy Barrel	1 in 8" (200 mm)	\$1,565
15158	816715015082	260 Remington Conversion Kits "C"	24" Carbon Fiber Barrel	1 in 8" (200 mm)	\$2,380

## MAGAZINES ACCESSORIES &amp; PARTS

Part #	UPC	Description	Retail
14674	816715013507	MRAD Breech Conversion Kit	\$440
12878	816715012418	Magazine, 338 Lapua Magnum, Black, 10 Round (Large Breech)	\$91
14077	816715013453	Magazine, 338 Lapua Magnum, Black, 10 Round "A" (Small Breech)	\$91
14396	816715016515	Magazine, 338 Norma Magnum & 300 Norma Magnum, Black, 10 Round "A" (Small Breech)	\$91
13552	816715013286	Magazine, 300 Win Mag/7mm Rem Mag, Black, 10 Round "B"	\$91
12885	816715013279	Magazine, 308 Win/6.5 Creedmoor/260 Rem, Black, 10 Round "C"	\$91
12613	816715011800	Bipod Assembly, Atlas Brand Clamp On for M1913 Rail	\$224
13332	816715011510	Spare Kit: Extractor, Extractor Spring, Cheek Piece Lock Knob, Front Assembly Pin, Ejector & Ejector Spring P (Large Breech Only)	\$127
14951	816715016225	Spare Kit: Extractor, Extractor Spring, Cheek Piece Lock Knob, Ejector, Ejector Spring, Ejector Roll Pin (Small Breech Only)	\$127
13337	816715012043	Buttplate Spacer Kit	\$31

## PRODUCT GUIDE

REC7<sup>®</sup>

## PRODUCTS

Part #	UPC	Caliber	Finish/Color	Barrel Length	Barrel Twist	Weight	Overall Length	Retail
17036	816715019035	5.56 NATO	Black Cerakote™	11.5" SBR (NFA ITEM)	1 in 7" (178 mm)	6.1 lbs. (2.3 kg)	25.9" (657 mm)	\$2,499
16124	816715019042	5.56 NATO	Black Cerakote™	11.5" Pistol	1 in 7" (178 mm)	6.1 lbs. (2.3 kg)	25.9" (657 mm)	\$2,499
17037	816715019066	5.56 NATO	Tungsten Grey Cerakote™	11.5" SBR (NFA Item)	1 in 7" (178 mm)	6.1 lbs. (2.3 kg)	25.9" (657 mm)	\$2,499
16122	816715019059	5.56 NATO	Tungsten Grey Cerakote™	11.5" Pistol	1 in 7" (178 mm)	6.1 lbs. (2.3 kg)	25.9" (657 mm)	\$2,499
17039	816715019073	5.56 NATO	Flat Dark Earth Cerakote™	11.5" SBR	1 in 7" (178 mm)	6.1 lbs. (2.3 kg)	25.9" (657 mm)	\$2,499
17038	816715019080	5.56 NATO	OD Green Cerakote™	11.5" SBR (NFA Item)	1 in 7" (178 mm)	6.1 lbs. (2.3 kg)	25.9" (657 mm)	\$2,499
17041	816715019028	5.56 NATO	Burnt Bronze Cerakote™	11.5" SBR (NFA Item)	1 in 7" (178 mm)	6.1 lbs. (2.3 kg)	25.9" (657 mm)	\$2,499
16980	816715019097	5.56 NATO	Black Cerakote™	16" Carbine	1 in 7" (178 mm)	7.2 lbs. (3.3 kg)	33.3" (845 mm)	\$2,499
16981	816715019103	5.56 NATO	Tungsten Grey Cerakote™	16" Carbine	1 in 7" (178 mm)	7.2 lbs. (3.3 kg)	33.3" (845 mm)	\$2,499
16983	816715019110	5.56 NATO	Flat Dark Earth Cerakote™	16" Carbine	1 in 7" (178 mm)	7.2 lbs. (3.3 kg)	33.3" (845 mm)	\$2,499
16982	816715019127	5.56 NATO	OD Green Cerakote™	16" Carbine	1 in 7" (178 mm)	7.2 lbs. (3.3 kg)	33.3" (845 mm)	\$2,499
16985	816715019134	5.56 NATO	Burnt Bronze Cerakote™	16" Carbine	1 in 7" (178 mm)	7.2 lbs. (3.3 kg)	33.3" (845 mm)	\$2,499
17064	816715019141	5.56 NATO	Black Cerakote™	16" Flyweight	1 in 7" (178 mm)	6.1 lbs. (2.3 kg)	34.5" (876 mm)	\$2,199
17065	816715019158	5.56 NATO	Tungsten Grey Cerakote™	16" Flyweight	1 in 7" (178 mm)	6.1 lbs. (2.3 kg)	34.5" (876 mm)	\$2,199
17067	816715019165	5.56 NATO	Flat Dark Earth Cerakote™	16" Flyweight	1 in 7" (178 mm)	6.1 lbs. (2.3 kg)	34.5" (876 mm)	\$2,199
17066	816715019172	5.56 NATO	OD Green Cerakote™	16" Flyweight	1 in 7" (178 mm)	6.1 lbs. (2.3 kg)	34.5" (876 mm)	\$2,199
17069	816715019189	5.56 NATO	Burnt Bronze Cerakote™	16" Flyweight	1 in 7" (178 mm)	6.1 lbs. (2.3 kg)	34.5" (876 mm)	\$2,199
17092	816715019196	5.56 NATO	Black Cerakote™	18" DMR	1 in 7.7" (196 mm)	7.91 lbs. (3.6 kg)	38.25" (976 mm)	\$2,799
17093	816715019202	5.56 NATO	Tungsten Grey Cerakote™	18" DMR	1 in 7.7" (196 mm)	7.91 lbs. (3.6 kg)	38.25" (976 mm)	\$2,799
17095	816715019219	5.56 NATO	Flat Dark Earth Cerakote™	18" DMR	1 in 7.7" (196 mm)	7.91 lbs. (3.6 kg)	38.25" (976 mm)	\$2,799
17094	816715019226	5.56 NATO	OD Green Cerakote™	18" DMR	1 in 7.7" (196 mm)	7.91 lbs. (3.6 kg)	38.25" (976 mm)	\$2,799

PRODUCT GUIDE



## REC7 | PRODUCTS CONTINUED

Part #	UPC	Caliber	Finish/Color	Barrel Length	Barrel Twist	Weight	Overall Length	Retail
17097	816715019233	5.56 NATO	Burnt Bronze Cerakote™	18" DMR	1 in 7.7" (196 mm)	7.9 lbs. (3.6 kg)	38.3" (976 mm)	\$2,799
17008	816715019288	6.8 SPC	Black Cerakote™	16" Carbine	1 in 10" (254 mm)	7.2 lbs. (3.3 kg)	33.3" (845 mm)	\$2,499
17009	816715019295	6.8 SPC	Tungsten Grey Cerakote™	16" Carbine	1 in 10" (254 mm)	7.2 lbs. (3.3 kg)	33.3" (845 mm)	\$2,499
17011	816715019301	6.8 SPC	Flat Dark Earth Cerakote™	16" Carbine	1 in 10" (254 mm)	7.2 lbs. (3.3 kg)	33.3" (845 mm)	\$2,499
17010	816715019318	6.8 SPC	OD Green Cerakote™	16" Carbine	1 in 10" (254 mm)	7.2 lbs. (3.3 kg)	33.3" (845 mm)	\$2,499
17013	816715019325	6.8 SPC	Burnt Bronze Cerakote™	16" Carbine	1 in 10" (254 mm)	7.2 lbs. (3.3 kg)	33.3" (845 mm)	\$2,499

## ACCESSORIES &amp; PARTS

Part #	UPC	Caliber	Barrel Type & Color	Barrel Length	Barrel Twist	Retail
16031	816715016270	5.56 NATO	5.56 NATO Complete Upper Receivers, BLACK	11.5" (All NFA Rules Apply)	1 in 7" (178 mm)	\$1,929
16032	816715016287	5.56 NATO	5.56 NATO Complete Upper Receivers, Tungsten Grey	11.5" (All NFA Rules Apply)	1 in 7" (178 mm)	\$1,929
16033	816715016294	5.56 NATO	5.56 NATO Complete Upper Receivers, OD Green	11.5" (All NFA Rules Apply)	1 in 7" (178 mm)	\$1,929
16034	816715016300	5.56 NATO	5.56 NATO Complete Upper Receivers, Flat Dark Earth	11.5" (All NFA Rules Apply)	1 in 7" (178 mm)	\$1,929
15236	816715014788	5.56 NATO	5.56 NATO Complete Upper Receivers, BLACK	16"	1 in 7" (178 mm)	\$1,929
15237	816715014795	5.56 NATO	5.56 NATO Complete Upper Receivers, Tungsten Grey	16"	1 in 7" (178 mm)	\$1,929
15238	816715014801	5.56 NATO	5.56 NATO Complete Upper Receivers, OD Green	16"	1 in 7" (178 mm)	\$1,929
15239	816715014818	5.56 NATO	5.56 NATO Complete Upper Receivers, Flat Dark Earth	16"	1 in 7" (178 mm)	\$1,929
16336	816715017055	5.56 NATO	5.56 NATO Complete Upper Receivers, Burnt Bronze	16"	1 in 7" (178 mm)	\$1,929
16037	816715016331	6.8 SPC	6.8 SPC Complete Upper Receivers, BLACK	11.5"	1 in 10" (254 mm)	\$1,929
16038	816715016348	6.8 SPC	6.8 SPC Complete Upper Receivers, Tungsten Grey	11.5" (All NFA Rules Apply)	1 in 10" (254 mm)	\$1,929
16039	816715016355	6.8 SPC	6.8 SPC Complete Upper Receivers, OD Green	11.5" (All NFA Rules Apply)	1 in 10" (254 mm)	\$1,929
16040	816715016362	6.8 SPC	6.8 SPC Complete Upper Receivers, Flat Dark Earth	11.5" (All NFA Rules Apply)	1 in 10" (254 mm)	\$1,929
15244	816715014863	6.8 SPC	6.8 SPC Complete Upper Receivers, BLACK	16"	1 in 10" (254 mm)	\$1,929
15245	816715014870	6.8 SPC	6.8 SPC Complete Upper Receivers, Tungsten Grey	16"	1 in 10" (254 mm)	\$1,929

15246	816715014887	6.8 SPC	6.8 SPC Complete Upper Receivers, OD Green	16"	1 in 10" (254 mm)	\$1,929
15247	816715014894	6.8 SPC	6.8 SPC Complete Upper Receivers, Flat Dark Earth	16"	1 in 10" (254 mm)	\$1,929
16356	816715017079	6.8 SPC	6.8 SPC Complete Upper Receivers, Burnt Bronze	16"	1 in 10" (254 mm)	\$1,929
13125	816715010971	6.8 SPC	Magazine, 6.8 SPC, Steel, 30 Round			\$38
68047-A	816715012074	6.8 SPC	Magazine, 6.8 SPC, Steel, PRI, 10 Round			\$41
13553	816715012081	5.56 NATO	Magazine, 5.56 NATO, Steel, PRI, 10 Round			\$41
12990	816715011473	5.56 NATO	5.56 Spare Kit: Firing Pin, Firing Pin Retaining Pin, Cam Pin, Gas Piston Return Spring, Detent Pin Retention E-			\$40
13856	816715011503	6.8 SPC	6.8 Spare Kit (NOT for M468): Firing Pin, Firing Pin Retaining Pin, Cam Pin, Gas Piston Return Spring, Detent			\$40
68022	816715010995		M468 Muzzle Break			\$26



## PRODUCT GUIDE

## REC7® DI

## PRODUCTS

Part #	UPC	Caliber	Color/Finish	Barrel Length	Barrel Twist	Weight	Overall Length	Retail
17831	816715018694	5.56 NATO	Black Cerakote™	10.25" Pistol	1 in 7" (178 mm)	5.5 lbs. (2.5 kg)	26.3" (667 mm)	\$1,899
17951	816715018700	5.56 NATO	Tungsten Grey Cerakote™	10.25" Pistol	1 in 7" (178 mm)	5.5 lbs. (2.5 kg)	26.3" (667 mm)	\$1,899
17950	816715018717	5.56 NATO	Flat Dark Earth Cerakote™	10.25" Pistol	1 in 7" (178 mm)	5.5 lbs. (2.5 kg)	26.3" (667 mm)	\$1,899
18021	816715018724	5.56 NATO	OD Green Cerakote™	10.25" Pistol	1 in 7" (178 mm)	5.5 lbs. (2.5 kg)	26.3" (667 mm)	\$1,899
18022	816715018731	5.56 NATO	Burnt Bronze Cerakote™	10.25" Pistol	1 in 7" (178 mm)	5.5 lbs. (2.5 kg)	26.3" (667 mm)	\$1,899
17120	816715018748	5.56 NATO	Black Cerakote™	16" Carbine	1 in 7" (178 mm)	6.2 lbs. (2.8 kg)	36" (914 mm)	\$1,899
17121	816715018755	5.56 NATO	Tungsten Grey Cerakote™	16" Carbine	1 in 7" (178 mm)	6.2 lbs. (2.8 kg)	36" (914 mm)	\$1,899
17123	816715018762	5.56 NATO	Flat Dark Earth Cerakote™	16" Carbine	1 in 7" (178 mm)	6.2 lbs. (2.8 kg)	36" (914 mm)	\$1,899
17122	816715018779	5.56 NATO	OD Green Cerakote™	16" Carbine	1 in 7" (178 mm)	6.2 lbs. (2.8 kg)	36" (914 mm)	\$1,899
17125	816715018786	5.56 NATO	Burnt Bronze Cerakote™	16" Carbine	1 in 7" (178 mm)	6.2 lbs. (2.8 kg)	36" (914 mm)	\$1,899
17148	816715018793	5.56 NATO	Black Cerakote™	18" DMR	1 in 7" (178 mm)	6.5 lbs. (2.9 kg)	38" (965 mm)	\$1,899
17149	816715018809	5.56 NATO	Tungsten Grey Cerakote™	18" DMR	1 in 7" (178 mm)	6.5 lbs. (2.9 kg)	38" (965 mm)	\$1,899
17151	816715018816	5.56 NATO	Flat Dark Earth Cerakote™	18" DMR	1 in 7" (178 mm)	6.5 lbs. (2.9 kg)	38" (965 mm)	\$1,899
17150	816715018823	5.56 NATO	OD Green Cerakote™	18" DMR	1 in 7" (178 mm)	6.5 lbs. (2.9 kg)	38" (965 mm)	\$1,899
17153	816715018830	5.56 NATO	Burnt Bronze Cerakote™	18" DMR	1 in 7" (178 mm)	6.5 lbs. (2.9 kg)	38" (965 mm)	\$1,899
17134	816715018847	6.8 SPC	Black Cerakote™	16" Carbine	1 in 10" (254 mm)	6.5 lbs. (2.9 kg)	36" (914 mm)	\$1,899
17135	816715018854	6.8 SPC	Tungsten Grey Cerakote™	16" Carbine	1 in 10" (254 mm)	6.2 lbs. (2.8 kg)	36" (914 mm)	\$1,899
17137	816715018861	6.8 SPC	Flat Dark Earth Cerakote™	16" Carbine	1 in 10" (254 mm)	6.2 lbs. (2.8 kg)	36" (914 mm)	\$1,899
17136	816715018878	6.8 SPC	OD Green Cerakote™	16" Carbine	1 in 10" (254 mm)	6.2 lbs. (2.8 kg)	36" (914 mm)	\$1,899
17139	816715018885	6.8 SPC	Burnt Bronze Cerakote™	16" Carbine	1 in 10" (254 mm)	6.2 lbs. (2.8 kg)	36" (914 mm)	\$1,899
17190	816715018892	300 Blackout	Black Cerakote™	10.25" Pistol	1 in 7" (178 mm)	5.5 lbs. (2.5 kg)	26.3" (667 mm)	\$1,899
17191	816715018908	300 Blackout	Tungsten Grey Cerakote™	10.25" Pistol	1 in 7" (178 mm)	5.5 lbs. (2.5 kg)	26.3" (667 mm)	\$1,899
17193	816715018915	300 Blackout	Flat Dark Earth Cerakote™	10.25" Pistol	1 in 7" (178 mm)	5.5 lbs. (2.5 kg)	26.3" (667 mm)	\$1,899
17947	816715018922	300 Blackout	Black Cerakote™	10.25" SBR (NFA Item)	1 in 7" (178 mm)	5.5 lbs. (2.5 kg)	30.3" (768 mm)	\$1,899

Part #	UPC	Caliber	Color/Finish	Barrel Length	Barrel Twist	Weight	Overall Length	Retail
17949	816715018939	300 Blackout	Tungsten Grey Cerakote™	10.25" SBR (NFA Item)	1 in 7" (178 mm)	5.5 lbs. (2.5 kg)	30.3" (768 mm)	\$1,899
17948	816715018946	300 Blackout	Flat Dark Earth Cerakote™	10.25" SBR (NFA Item)	1 in 7" (178 mm)	5.5 lbs. (2.5 kg)	30.3" (768 mm)	\$1,899
18019	816715018953	300 Blackout	OD Green Cerakote™	10.25" SBR (NFA Item)	1 in 7" (178 mm)	5.5 lbs. (2.5 kg)	30.3" (768 mm)	\$1,899
18020	816715018960	300 Blackout	Burnt Bronze Cerakote™	10.25" SBR (NFA Item)	1 in 7" (178 mm)	5.5 lbs. (2.5 kg)	30.3" (768 mm)	\$1,899
17176	816715018977	300 Blackout	Black Cerakote™	16" Carbine	1 in 7" (178 mm)	6.2 lbs. (2.8 kg)	36" (914 mm)	\$1,899
17177	816715018984	300 Blackout	Tungsten Grey Cerakote™	16" Carbine	1 in 7" (178 mm)	6.2 lbs. (2.8 kg)	36" (914 mm)	\$1,899
17179	816715018991	300 Blackout	Flat Dark Earth Cerakote™	16" Carbine	1 in 7" (178 mm)	6.2 lbs. (2.8 kg)	36" (914 mm)	\$1,899
17178	816715019004	300 Blackout	OD Green Cerakote™	16" Carbine	1 in 7" (178 mm)	6.2 lbs. (2.8 kg)	36" (914 mm)	\$1,899
17181	816715019011	300 Blackout	Burnt Bronze Cerakote™	16" Carbine	1 in 7" (178 mm)	6.2 lbs. (2.8 kg)	36" (914 mm)	\$1,899

## ACCESSORIES &amp; PARTS

Part #	UPC	Caliber	Description	Retail
13125	816715010971	6.8 SPC	Magazine, 6.8 SPC, Steel, 30 Round	\$38
68047-A	816715012074	6.8 SPC	Magazine, 6.8 SPC, Steel, PRI, 10 Round	\$41
13553	816715012081	5.56 NATO	Magazine, 5.56 NATO, Steel, PRI, 10 Round	\$41
12990	816715011473	5.56 NATO	5.56 Spare Kit: Firing Pin, Firing Pin Retaining Pin, Cam Pin, Gas Piston Return Spring, Detent Pin Retention E-	\$40
13856	816715011503	6.8 SPC	6.8 Spare Kit (NOT for M468): Firing Pin, Firing Pin Retaining Pin, Cam Pin, Gas Piston Return Spring, Detent	\$40
68022	816715010995		M468 Muzzle Break	\$26



## PRODUCT GUIDE

**MODEL 99™****PRODUCTS**

Part #	UPC	Caliber	Color/Finish	Barrel Length	Barrel Twist	Weight	Overall Length	Retail
13305	816715010254	50 BMG	Black Anodized	29" Fluted Barrel	1 turn in 15" (381 mm)	23 lbs (10.4 kg)	47" (1190 mm)	\$4,120
13143	816715011688	50 BMG	Black Anodized	29" Fluted Barrel	1 turn in 15" (381 mm)	23 lbs (10.4 kg)	47" (1190 mm)	\$5,532
13307	816715011398	50 BMG	Black Anodized	32" Heavy Barrel	1 turn in 15" (381 mm)	25 lbs (11.4 kg)	50" (1270 mm)	\$3,967
13145	816715011701	50 BMG	Black Anodized	32" Heavy Barrel	1 turn in 15" (381 mm)	25 lbs (11.4 kg)	50" (1270 mm)	\$5,379
14032	816715012548	50 BMG	Flat Dark Earth Cerakote™	29" Fluted Barrel	1 turn in 15" (381 mm)	23 lbs (10.4 kg)	47" (1190 mm)	\$4,222
14033	816715012531	50 BMG	Flat Dark Earth Cerakote™	29" Fluted Barrel	1 turn in 15" (381 mm)	23 lbs (10.4 kg)	47" (1190 mm)	\$5,634
13273	816715012012	50 BMG	Flat Dark Earth Cerakote™	32" Heavy Barrel	1 turn in 15" (381 mm)	25 lbs (11.4 kg)	50" (1270 mm)	\$4,069
14041	816715012500	50 BMG	Flat Dark Earth Cerakote™	32" Heavy Barrel	1 turn in 15" (381 mm)	25 lbs (11.4 kg)	50" (1270 mm)	\$5,481
13303	816715010247	416 Barrett	Black Anodized	32" Heavy Barrel	1 turn in 12" (305 mm)	25 lbs (11.4 kg)	50" (1270 mm)	\$3,967
13141	816715011664	416 Barrett	Black Anodized	32" Heavy Barrel	1 turn in 12" (305 mm)	25 lbs (11.4 kg)	50" (1270 mm)	\$5,379
13142	816715011671	416 Barrett	Black Anodized	32" Heavy Barrel	1 turn in 12" (305 mm)	25 lbs (11.4 kg)	50" (1270 mm)	\$6,806
13272	816715012005	416 Barrett	Flat Dark Earth Cerakote™	32" Heavy Barrel	1 turn in 12" (305 mm)	25 lbs (11.4 kg)	50" (1270 mm)	\$4,069
14039	816715012555	416 Barrett	Flat Dark Earth Cerakote™	32" Heavy Barrel	1 turn in 12" (305 mm)	25 lbs (11.4 kg)	50" (1270 mm)	\$5,481

**MODEL 99 | PRODUCTS CONTINUED****ACCESSORIES & PARTS**

Part #	UPC	Description	Retail
12774	816715010674	QDL Suppressor (NFA Item), Black, Up to 50 BMG (Suppressor Adapter Required)	\$2,978
12364	816715010667	QDL Suppressor (NFA Item), Flat Dark Earth, Up to 50 BMG (Suppressor Adapter Required)	\$2,978
14531	816715012494	Suppressor Adapter, Muzzle Brake, Black	\$445
13351	816715010919	Bipod Assembly, Black, Spiked Feet	\$308
13348	816715011022	Monopod Kit, Black (Must Have Monopod Socket)	\$152
13330	816715011480	Spare Kit: Trigger Housing Pin, Extractor, Extractor Spring, Bipod Assy. Pin, & Pin Assy.	\$56
13335	816715010742	Retro Fit 3 Port Muzzle Brake	\$231

## PRODUCT GUIDE

**240LW & LWS****PRODUCTS**

Part #	Model	UPC	Caliber	Color	Barrel Length	Barrel Twist	Weight	Overall Length	Rate of Fire	Retail
16511	240LW	N/A	7.62 x 51 mm NATO	Black	21.5" (546 mm)	1 turn in 12" (305 mm)	20.9 lbs (9.4 kg)	43" (1092 mm) Long Barrel Collapsed to 47" (1194 mm) Long Barrel Extended	550 Rds / min	N/A
16684	240LW Post 1986 Dealer Sample	816715017512	7.62 x 51 mm NATO	Black	21.5" (546 mm)	1 turn in 12" (305 mm)	20.9 lbs (9.4 kg)	43" (1092 mm) Long Barrel Collapsed to 47" (1194 mm) Long Barrel Extended	550 Rds / min	N/A
17773	240LWS	N/A	7.62 x 51 mm NATO	FDE	18.5" (469 mm)	1 turn in 12" (305 mm)	19.8 lbs (8.9 kg)	38.5" (978 mm) Short Barre Collapsed to 40.0" (1016 mm) Short Barrel Extended	550 Rds / min	N/A

PRODUCT GUIDE



## PRODUCT GUIDE

**MODEL 95™****PRODUCTS**

Part #	UPC	Caliber	Color/Finish	Barrel Length	Barrel Twist	Weight	Overall Length	Retail
13312	816715010223	50 BMG	Manganese Phosphate Receiver	29" Fluted Barrel	1 turn in 15" (381 mm)	23.5 lbs (10.7 kg)	45" (1143 mm)	\$6,671
13140	816715011657	50 BMG	Manganese Phosphate Receiver	29" Fluted Barrel	1 turn in 15" (381 mm)	23.5 lbs (10.7 kg)	45" (1143 mm)	\$8,084

**ACCESSORIES & PARTS**

Part #	UPC	Description	Retail
12774	816715010674	QDL Suppressor (NFA Item), Black, Up to 50 BMG (Suppressor Adapter Required)	\$2,978
12364	816715010667	QDL Suppressor (NFA Item), Flat Dark Earth, Up to 50 BMG (Suppressor Adapter Required)	\$2,978
14531	816715012494	Suppressor Adapter, Muzzle Brake, Black	\$445
13351	816715010919	Bipod Assembly, Black, Spiked Feet	\$308
13348	816715011022	Monopod Kit, Black (Must Have Monopod Socket)	\$152
M95- SPKIT	816715011497	Spare Kit: Trigger Housing Pin, Extractor, Extractor Spring, Extractor Plunger, Rear Pin Assy., Front Pin Assy., Bolt Carrier Pin, Bolt Carrier Hair Pin, & 2 Firing Springs	\$113
13335	816715010742	Retro Fit 3 Port Muzzle Brake	\$231

## PRODUCT GUIDE

**ZERO GAP RINGS****PRODUCTS**

Part #	UPC	Description	RETAIL
13321	816715010100	30mm, Low (1.0")	\$205
13322	816715010117	30mm, Medium (1.1")	\$205
13323	816715010124	30mm, High (1.3")	\$205
13324	816715010131	30mm, Ultra High (1.4")	\$205
66868	816715010452	34mm, Medium (1.1")	\$205
66869	816715010940	34mm, Ultra High (1.4")	\$205
15364	816715016652	35mm, Medium (1.1")	\$205
15363	816715016669	35mm, Ultra High (1.4")	\$205



## PRODUCT GUIDE

# QDL SUPRESSOR

## PRODUCTS

Part #	UPC	Description	RETAIL
12774	816715010674	QDL Suppressor (NFA Item), Black, Up to 50 BMG (Suppressor Adapter Required)	\$2,978
12364	816715010667	QDL Suppressor (NFA Item), Flat Dark Earth, Up to 50 BMG (Suppressor Adapter Required)	\$2,978
14531	816715012494	Suppressor Adapter, Muzzle Brake, Black (ONLY for use on M95 and M99 Rifles)	\$445

## PRODUCT GUIDE

# AM & DC SUPRESSOR

## PRODUCTS

Part #	UPC	Description	Retail
15309	816715015747	AM30, Adapter Mount Suppressor (NFA Item), Natural Titanium Finish (adapter mount not included)	\$1,151
15265	816715015754	AM30, Adapter Mount Suppressor (NFA Item), Black Finish (adapter mount not included)	\$1,151
15311	816715015761	AM30, Adapter Mount Suppressor (NFA Item), Flat Dark Earth Finish (adapter mount not included)	\$1,151
15315	816715015778	DC30, Direct Connect Suppressor (NFA Item), Natural Titanium Finish	\$1,151
15316	816715015785	DC30, Direct Connect Suppressor (NFA Item), Black Finish	\$1,151
15317	816715015792	DC30, Direct Connect Suppressor (NFA Item), Flat Dark Earth Finish	\$1,151
16128	816715016249	AM30, Muzzle Brake Adapter Mount (required to use with the AM30)	\$198
15306	816715015808	AM338, Adapter Mount Suppressor (NFA Item), Natural Titanium Finish (adapter mount not included)	\$1,530
15307	816715015815	AM338, Adapter Mount Suppressor (NFA Item), Black Finish (adapter mount not included)	\$1,530
15308	816715015822	AM338, Adapter Mount Suppressor (NFA Item), Flat Dark Earth Finish (adapter mount not included)	\$1,530
15312	816715015839	DC338, Direct Connect Suppressor (NFA Item), Natural Titanium Finish	\$1,530
15313	816715015846	DC338, Direct Connect Suppressor (NFA Item), Black Finish	\$1,530
15314	816715015853	DC338, Direct Connect Suppressor (NFA Item), Flat Dark Earth Finish	\$1,530
16129	816715016256	AM338, Muzzle Brake Adapter Mount (required to use with the AM338)	\$220

## PRODUCT GUIDE

# AMMUNITION

## PRODUCTS

Part #	UPC	Description	Retail
14670	816715015723	Barrett Headstamp, M33 Ball, 10 Round Box	\$72
14671	816715015730	Barrett Headstamp, M33 Ball, 250 Round Case	\$1,811
16424	816715017086	Lake City 4+1 Linked M33 Ball/M17 Tracer, 100 Round Can	\$356
16425	816715017093	Lake City M33 Ball, Delinked, 100 Round Can	\$356
16426	816715017109	Lake City M17 Tracer, Delinked, 100 Round Can	\$356
16427	816715017116	New M9 Links for 50 BMG, Bag of 100	\$10
17221	816715018342	416 Barrett, 452 GR MTAC, Case of 80	\$712
17222	816715018359	416 Barrett, 452 GR MTAC, Box of 10	\$89
32314	816715011428	Bullets, Cutting Edge, Solid Copper, 446gr, 25 Count	\$52
41613	816715010636	Bullets, Turned Brass VLD, 20 Count	\$52
13494	816715012098	Primed Brass, Barrett Head Stamp, 25 Count	\$73



#### **BARRETT HEADQUARTERS**

P.O. Box 1077  
Murfreesboro, TN 37133

**Phone** 615.896.2938

**Fax** 615.896.7313

**Web** [Barrett.net](http://Barrett.net)

---

#### **CUSTOMER SERVICE / TECH SUPPORT**

[mail@barrett.net](mailto:mail@barrett.net)

---

#### **TRAINING**

[training@barrett.net](mailto:training@barrett.net)

---

#### **LAW ENFORCEMENT**

[le@barrett.net](mailto:le@barrett.net)

---

#### **MILITARY**

[military@barrett.net](mailto:military@barrett.net)

---

#### **DEALER DIRECT**

[dealer@barrett.net](mailto:dealer@barrett.net)

---

#### **MARKETING & MEDIA**

[media@barrett.net](mailto:media@barrett.net)

---

#### **INTERNATIONAL**

[international@barrett.net](mailto:international@barrett.net)

**DISCLAIMER** | All combat sequences are simulated. Barrett products are offered only for target, hobby, recreational, sport, defensive, and agency use where not otherwise prohibited by law.

© 2018 BARRETT / ALL RIGHTS RESERVED



Barrett has grown to be the world leader in long range rifle design and manufacturing. Their products are used by civilian sport shooters, law enforcement agencies, the United States military, and more than 70 State Department approved countries across the world. The Barrett Quality Management System (QMS) has received the prestigious ISO 9001:2015 certification for the design and manufacture of firearms, ammunition, accessories, and in the training provided for those systems.

The obsession with firearms excellence runs deep in the Barrett family blood. "It's one thing to manufacture guns and another to live and breathe them. Whether we're carefully assembling our latest rifle, engineering scope rings to be stronger than ever, or increasing the velocity and precision of the ammunition itself-we're always working with one goal in mind: there's always a better way." - Ronnie Barrett, Barrett CEO and Founder

**BARRETT.NET**

